

UNIVERSITÄT DER BUNDESWEHR MÜNCHEN
Fakultät für Elektrotechnik und Informationstechnik

Some Very Important Research

Johannes Ziegmann

Vollständiger Abdruck der von der promotionsführenden Einrichtung Fakultät für Elektrotechnik und Informationstechnik der Universität der Bundeswehr München zur Erlangung des akademischen Grades eines

Doktors der Ingenieurwissenschaften (Dr.-Ing.)

genehmigten Dissertation.

Vorsitzende/-r:

Prüfende der Dissertation:

1. Prof. Dr.-Ing. Christian Endisch
2. Prof. Dr.-Ing. habil. Thomas Weyh

Die Dissertation wurde am bei der Universität der Bundeswehr München eingereicht und durch die promotionsführende Einrichtung Fakultät für Elektrotechnik und Informationstechnik am angenommen.

Acknowledgments

Thank you!

Abstract

In this work...

Kurzfassung

In dieser Arbeit...

“ . . . all models are approximations. Essentially, all models are wrong, but some are useful. However, the approximate nature of the model must always be borne in mind. . . . ” (George Box (1987))

“The most that can be expected from any model is that it can supply a useful approximation to reality: All models are wrong; some models are useful ” (George Box)

Contents

List of Figures	xi
List of Tables	xiii
Notational Conventions	xv
Acronyms and Abbreviations	xvii
1 Introduction	1
1.1 Context and motivation	1
1.2 Survey of related work	2
1.3 Research objectives and thesis outline	2
2 Background / Theory	3
2.1 The Bayesian Framework	3
2.1.1 Modeling via Exchangeability	3
2.2 Exponential Families	7
2.2.1 Properties of the Canonical Exponential Family	9
2.2.2 Interpretation as Linearly Constrained Maximum Entropy Distribution	9
2.2.3 Examples	9
2.3 Sufficient Statistics	9
2.4 Incorporating Prior Knowledge	11
2.4.1 Conjugate Priors	11
2.4.2 Multinomial Observations	11
2.4.3 Gaussian Observations	11
2.4.4 Multivariate Linear Regression Model	11
2.5 Graphical Models	11
2.5.1 A Brief Overview	11
2.5.2 Directed Graphical Models	11
2.5.3 Undirected Graphical Models	11
2.5.4 Belief Propagation	11
2.6 Hidden Markov Model	11
2.6.1 Forward-Backward Algorithm	11
2.6.2 Viterbi Algorithm	11
2.7 State Space Models	11
2.7.1 Standard Discrete-Time Linear-Gaussian State Space Formulation	11
2.7.2 Vector Autoregressive Processes	11
2.7.3 Switching Linear Dynamic Systems	11
2.7.4 Stochastic Realization Theory	11
2.7.5 Kalman Filtering and Smoothing	11

2.8	Markov Chain Monte Carlo	11
2.8.1	Monte Carlo Integration	11
2.8.2	The Metropolis-Hastings Algorithm	11
2.8.3	Gibbs Sampling	11
2.8.4	Auxiliary, Blocked, and Collapsed Gibbs Samplers	11
2.9	Bayesian Nonparametric Methods	11
2.9.1	Dirichlet Processes	11
2.9.2	Dirichlet Process Mixture Models	11
2.9.3	Hierarchical Dirichlet Processes	11
2.9.4	Beta Process	11
3	Route/Trajectory Prediction	13
3.1	Section	13
3.1.1	Subsection	13
4	Prediction of driver influenced parameter (velocity and longitudinal and lateral acceleration)	15
4.1	Section	15
4.1.1	Subsection	15
5	Fifth Chapter	17
5.1	Section	17
5.1.1	Subsection	17
6	Conclusion	19
6.1	Section	19
6.1.1	Subsection	19
7	Test Chapter	21
7.1	ToDo's	21
7.2	Notes	22
7.3	FixMe	22
7.4	Cite	23
7.5	Glossaries	23
7.6	Reference	23
7.7	Macros	23
7.7.1	Equations	23
7.7.2	Function	24
7.8	Table	24
7.9	Figures	25
8	Heading on level 0 (chapter)	29
8.1	Heading on level 1 (section)	29
8.1.1	Heading on level 2 (subsection)	29
8.2	Lists	30
8.2.1	Example for list (itemize)	30
8.2.2	Example for list (enumerate)	31

8.2.3	Example for list (description)	32
9	Heading on level 0 (chapter)	33
9.1	Heading on level 1 (section)	33
9.1.1	Heading on level 2 (subsection)	34
9.2	Lists	38
9.2.1	Example for list (itemize)	38
9.2.2	Example for list (enumerate)	42
9.2.3	Example for list (description)	45
A	Appendix	55
	Bibliography	XIX

List of Figures

7.2	Polynominterpolynom und Runge-Phänomen	25
7.1	Testplot	25
7.3	Basisfunktionen eines B-Splines	26

List of Tables

7.1 Bla Bla 24

Notational Conventions

- ℱ sets of fett numbers ...
- ℵ sets of XXX numbers ...

Acronyms and Abbreviations

ANN	Artificial neural network
i.i.d.	independent and identically distributed
MSE	Mean-squared-Error

Introduction

1.1 Context and motivation

Accurate prediction of the individual driver behavior is essential for various automotive future technologies. Forecasting applications addressing the driver behavior are for instance risk assessment of traffic scenarios for active and passive safety, automated driving, driving route prediction (forecasting) and control functions or energy management and strategies [1]–[3]. With increasing and more accurate information of vehicle and environmental data ensuring precise predictions, advanced driver assistance systems (ADAS) combined with driver models guarantee high reliability.

Using the back end server-side with online data, modern navigation systems provide the ADAS and driver model with a high amount of forecast information of the vehicle environment. Based on the ADAS application, the prediction horizon can be classified into short-range and long-range predictions. The two categories differ mainly in the range of the input data. While short-term predictions affect to the vehicle sensors ranging a few hundreds meters in front of the ego-vehicle motion, long-range prediction uses navigation and road based data approaches minimizing the time dependency in the forecast.

The work focuses on long-range prediction horizons ranging from a few kilometers ahead to the final destination. Automotive applications using the long-range prediction horizon are for instance efficiency systems, which are optimization strategies of hybrid electric vehicles (HEVs) and range calculation for battery electric vehicles (BEVs). Thereby the precision of the upcoming power and velocity prediction is instrumental for the overall vehicle power consumption of HEVs and influences the range forecast of BEVs [4].

Focusing the range calculation and energy forecast of BEVs, main influences of predictive energy consumption are given by the vehicle parameters, which are for instance the vehicle mass together with the driving resistance coefficients and the driver depended vehicle dynamics given by the individual driving velocity and its time derivatives [5]. With individual velocity prediction the ADAS can give premature feedback to the driver enabling a satisfactory and reliable systems for the customer.

Long-range prediction of the individual velocity is challenging though, since the probability

of the predicted speed occurrence decreases with an increasing prediction horizon [6]. The prediction output quantity is influenced by several uncertain factors, which are for instance traffic jams, time dependent road surfaces and weather conditions. In addition the driver behavior can change over time, which leads to a complex system that is hard to grasp with pure physical relations. To model the driver behavior machine learning algorithms are used. Latest research analyzed neural networks, non-parametric regressions or stochastic prediction models [4], [6]–[9].

While [4], [6], [9] do not take environmental features and [8] does not take the predicted continuous vehicle velocity into account, this approach investigates modeling the driver individual behavior with a stochastic process given the environment. The work examines the modeling procedure in combination with the influences on the driver behavior based on environmental factors, e.g. road curvature. The parameters and distributions of this process are learned based on individual naturalistic driving data. Thereby, linearity and Gaussian distribution assumption for underlying densities that lead to the Kalman Filter and Rauch-Tung-Striebel Smoother algorithms showed to be too limited. The use of non-parametric distributions, making numerical methods like particle-based algorithms essential, showed far more promising results for modeling driver individual velocity behavior.

The stochastic algorithms together with the online traffic speed source and a neural network approach given [7], are evaluated by using 1500 km real world naturalistic driving data. The study data refers to 39 driving tracks and includes 8 different drivers. On the basis of the data set, a total of 5 different velocity prediction algorithms are trained and validated. The stochastic models show high accuracy and precise prediction result. Following the remainder of this paper is organized. In Sec. II, the problem formulation with the modeling procedure from the driving surrounding to the vehicle dynamic including driver behavior is presented. Additionally conditional stochastic independence is defined guaranteeing the use of hidden Markov models. Furthermore the database of the study with a classification method are described. The four stochastic prediction models are explained in Section III, starting with the linear and Gaussian assumption, Sec. III-A. The nonparametric stochastic model is investigated in Subsection III-B. Finally, the results of the prediction algorithms are shown in Section IV with the subsequent conclusion in Sec. V.

1.2 Survey of related work

1.3 Research objectives and thesis outline

Background / Theory

THIS theory chapter reviews statistical methodologies upon which the contributions are based. Section xxx

For the models exact inference is considered to be infeasible, leading to Markov chain Monte Carlo techniques that are outlined in Sec. xxx. Finally Sec. xxx concludes the background material

2.1 The Bayesian Framework

In this section we provide a brief motivation for the Bayesian approach and establish some concepts that reappear throughout this thesis. The overarching goal of the thesis is then to examine the flexibility a Bayesian approach can provide in the case of learning dynamical unknown systems.

Types of probability - classical, frequentist, and Bayesian If we compare the so-called frequentist philosophy of statistical analysis to Bayesian inference the difference is that in Bayesian inference the probability of an event does not mean the proportion of the event in an infinite number of trials, but the uncertainty of the event in a single trial. Because models in Bayesian inference are formulated in terms of probability distributions, the probability axioms and computation rules of the probability theory (see, e.g., Shiryaev, 1996) also apply in Bayesian inference.

2.1.1 Modeling via Exchangeability

The concept of exchangeability is central to many statistical approaches, and may be viewed as critical in motivating Bayesian statistics. Let us assume that we are aggregating data in an attempt to make predictions about future values of the random process we are observing. If we were to make the strong assumption of the data being independent, we would treat every new data point individually without using past observations to predict future observations

since:

$$p(y_1, \dots, y_n) = \prod_{i=1}^n p(y_i) \quad (2.1)$$

implies that

$$p(y_{n+1}, \dots, y_m | y_1, \dots, y_n) = p(y_{n+1}, \dots, y_m). \quad (2.2)$$

A weaker assumption that often better describes the data we encounter is that of exchangeability, which states that the order we encounter the data is inconsequential.

Definition 2.1.1. *A sequence of random variables y_1, y_2, \dots, y_n is said to be finitely exchangeable if*

$$y_1, y_2, \dots, y_n \stackrel{\mathcal{D}}{=} y_{\pi(1)}, y_{\pi(2)}, \dots, y_{\pi(n)} \quad (2.3)$$

for every permutation π on $\{1, \dots, n\}$. Here, we use the notation $\stackrel{\mathcal{D}}{=}$ to mean equality in distribution. From this definition, we see that independence implies exchangeability, but not vice versa. We are often in settings where data is continually accumulated, or in which fixing an upper bound n is challenging. We would thus like to formalize a notion of exchangeability for infinite sequences.

Definition 2.1.2. *A sequence y_1, y_2, \dots is said to be infinitely exchangeable if every finite subsequence is finite exchangeable [15]. As is demonstrated in Bernardo and Smith [15], not every finitely exchangeable sequence can be embedded in an infinitely exchangeable sequence.*

Exchangeability has simplifying implications for inference since we can simply ignore the order in which the data arrive. Sometimes, exchangeability is too strong of an assumption. Relaxations include considering *partially exchangeable* data where some auxiliary information partitions the data into exchangeable sets. For example, consider a person flipping two biased coins, one on even throws and the other on odd throws. The data are exchangeable within the set of odd or even tosses if these labels are provided. There are many possible extensions and variations on the standard exchangeability model; however, the end goal is to group data into exchangeable, and thus relatively simple, blocks for which inference is more tractable.

A very important result arising from the assumption of exchangeable data is what is typically referred to as *de Finetti's theorem*. This theorem states that an infinite sequence of random variables y_1, y_2, \dots, y_n is exchangeable if and only if there exists a random probability measure ν with respect to which y_1, y_2, \dots, y_n are conditionally independent and identically distributed (i.i.d.) with distribution ν . Furthermore, this random measure can be viewed as the limiting empirical measure. De Finetti actually proved this in the case of binary

random variables de Finetti [33], with the more general extension to arbitrary real-valued exchangeable sequences made by Hewitt and Savage [66] and Ryll-Nardzewski [146].

We have seen in Theorem 2.1.1 that for infinitely exchangeable binary sequences, there exists a random probability measure ν that concentrates on $\{0, 1\}$ implying that this measure can be uniquely described by a single parameter θ . One can straightforwardly extend the argument in Theorem 2.1.1 to infinitely exchangeable sequences taking values in $\{1, \dots, K\}$; here, the random measure yielding the data i.i.d. concentrates on $\{1, \dots, K\}$ and is thus uniquely defined by a $(K - 1)$ -dimensional parameter $\theta = \{\theta_1, \dots, \theta_{K-1}\}$ [15]. Analogous to the examples presented in Example 2.1.2, possible underlying games include rolling a K -sided weighted die or drawing from an urn with K different colored balls. When moving to infinitely exchangeable sequences taking values in the reals, the random probability measures ν can be arbitrarily complex and are, in general, defined by infinitely many parameters (i.e., ν is a generic element of $\mathcal{P}(\mathbb{R})$.) Some special cases exist in which the parametrization remains finite. For example, if ν is almost surely a Gaussian distribution, the parametrization solely consists of a mean and variance. The more general case in which θ may be an infinite-dimensional parameter motivates the development of Bayesian nonparametric methods, some of which we explore in this thesis. For example, the Dirichlet process of Sec. xxx defines a distribution on probability measures that concentrate at a countably infinite number of elements of the reals (or the more general spaces we consider in Sec. xxx) When we limit ourselves to the more restrictive class of finite-dimensional θ (e.g., Bernoulli, multinomial, Gaussian random variables), we can invoke the following corollaries.

Corollary 2.1.3. *Assuming the required densities exist, and assuming the conditions of Theorem 2.1.2 hold, then there exists a distribution function Q such that the joint density of y_1, \dots, y_n is of the form*

$$p(y_1, \dots, y_n) = \int_{\theta} \prod_{t=1}^n p(y_t | \vartheta) dQ(\vartheta), \quad (2.4)$$

with $p(\cdot | \vartheta)$ representing the density function corresponding to the finite-dimensional parameter $\vartheta \in \theta$.

From the above corollary, it is simple to see how the de Finetti theorem motivates the concept of a prior distribution $Q(\cdot)$ and a likelihood function $p(y | \cdot)$

Corollary 2.1.4. *Given that the conditions of Corollary 2.1.1 hold, then the predictive density is given by*

$$p(y_{m+1}, \dots, y_n | y_1, \dots, y_m) = \int_{\theta} \prod_{i=m+1}^n p(y_i | \vartheta) dQ(\vartheta | y_1, \dots, y_m), \quad (2.5)$$

where

$$dQ(\vartheta|y_1, \dots, y_m) = \frac{\prod_{i=1}^m p(y_i|\theta) dQ(\theta)}{\int_{\theta} \prod_{i=1}^m p(y_i|\vartheta) dQ(\vartheta)}. \quad (2.6)$$

Proof. The result follows directly from employing

$$p(y_{m+1}, \dots, y_n|y_1, \dots, y_m) = \frac{p(y_1, \dots, y_n)}{p(y_1, \dots, y_m)}, \quad (2.7)$$

along with Corollary 2.1.1.

From the form of the predictive density in Eq. (2.10), we see that our view of the existence of an underlying random parameter θ yielding the data i.i.d. has not changed. Instead, we have simply updated our prior belief $Q(\theta)$ into a posterior belief $Q(\theta|y_1, \dots, y_m)$ through an application of Bayes rule:

$$p(\theta|y) = \frac{p(y|\theta) p(\theta)}{\int_{\theta} p(y|\vartheta) p(\vartheta) d\vartheta} \quad (2.8)$$

$$= \frac{p(y|\theta) p(\theta)}{p(y)} \quad (2.9)$$

Here, we have written the rule in its simplest form assuming that a density on θ exists in addition to the conditional density on y . Although one can view the computation of the predictive distribution in Eq. (2.10) as the objective in Bayesian statistics, we will often limit our discussion to the process of forming the posterior distribution in Eq. (2.11) from the prior by incorporating observations, since this is a fundamental step in examining the predictive distribution.

From a practical perspective, we never have an infinite sequence of observations from which to characterize our prior distribution. Furthermore, even if we had such a quantity, the probability measure that the de Finetti theorem would suggest as yielding the data i.i.d. might be arbitrarily complex. Thus, we are left with two competing pragmatic choices in defining our prior:

1. Tractable inference,
2. Modeling flexibility.

The issue of tractable inference often motivates the use of conjugate priors, as discussed in Sec. [xxx](#). The goal of flexibility in our models leads to the study of Bayesian nonparametric methods. A brief introduction to some specific classes of nonparametric methods that maintain computational tractability is presented in Sec. [xxx](#).

Another key aspect of the Bayesian framework we have established is in characterizing a model, or likelihood distribution, $p(y|\theta)$ for how our data are generated conditioned a parameter value θ . This choice, too, is often motivated by practical considerations that

are typically coupled with those of choosing a prior distribution. We do not develop a full analysis of model selection in this thesis, but begin the exploration in Sec. [xxx](#).

As practitioners, we do not actually know the underlying generative process, but we can use a combination of our insight on the process (e.g., we know we are observing heights from a given population and heights tend to be well-modeled as Gaussian) and our adherence to computational limitations to define a model.

2.2 Exponential Families

Exponential families represent a fundamental class of distributions in statistics. They arise as the answer to numerous, albeit related, questions.

Within the Bayesian framework: For what class of models does there exist a prior that leads to computationally tractable inference [15, 141]?

Frequentists arrive at the exponential family when asking: If there exists an efficient estimator, can we describe the class of models from which the data could have been generated [87, 184]?

Common to both domains: What distribution is maximally random while being consistent with a set of moment constraints [15, 79, 116]?

Definition 2.2.1. A parametrized family of distributions $\mathcal{P}_\theta = \{P_\theta\}$ is a k -parameter exponential family with natural parameter $\boldsymbol{\eta}(\cdot) = [\eta_1(\cdot), \dots, \eta_k(\cdot)]^\top$ natural statistic $\mathbf{t}(\cdot) = [t_1(\cdot), \dots, t_k(\cdot)]^\top$, and base distribution $p(\cdot) \propto e^{\beta(\cdot)}$ if each member P_θ of the family has a density of the form

$$p(\mathbf{y}|\boldsymbol{\theta}) = \exp \left\{ \boldsymbol{\eta}^\top(\boldsymbol{\theta})\mathbf{t}(\mathbf{y}) - \alpha(\boldsymbol{\theta}) + \beta(\mathbf{y}) \right\} \quad (2.10)$$

$$= \exp \left\{ \sum_{i=1}^k \eta_i(\boldsymbol{\theta})t_i(\mathbf{y}) - \alpha(\boldsymbol{\theta}) + \beta(\mathbf{y}) \right\} \quad (2.11)$$

with respect to a dominating measure¹ μ . Here, y^2 is a point in the sample space \mathcal{Y} , which represents the support of the density. The function $\alpha(\cdot)$ is referred to as the log-partition function and ensures that the probability density integrates to 1. We will denote this family by $\boldsymbol{\epsilon}(\boldsymbol{\theta}; \boldsymbol{\nu}(\cdot), \mathbf{t}(\cdot), \beta(\cdot))$.

The set of admissible parameter values, or the natural parameter space, for which a con-

¹The dominating measure is the assumed measure on the considered measurable space, and as such provides the measure with respect to which the Radon-Nikodym derivative is taken when defining densities (amongst other measure-theoretic operations one could examine).

²We use the notation \mathbf{y} rather than y to indicate that this quantity is allowed to be vector valued.

stant $\alpha(\boldsymbol{\theta})$ exists are those such that

$$\int \exp \left\{ \sum_{i=1}^k \eta_i(\boldsymbol{\theta}) t_i(\mathbf{y}) - \alpha(\boldsymbol{\theta}) + \beta(\mathbf{y}) \right\} d\mathbf{y} < \infty \quad (2.12)$$

We could generalize Eq. (2.15) and the results to follow for a given measure μ rather than the assumed Lebesgue (or where appropriate, counting) measure. However, we will omit this level of mathematical formality.

It is common to restrict oneself to examining families of distributions whose support, i.e., the set of \mathbf{y} such that $p(\mathbf{y}|\boldsymbol{\theta}) > 0$, does not depend upon $\boldsymbol{\theta}$.

Definition 2.2.2. *An exponential family $\epsilon(\boldsymbol{\theta}; \boldsymbol{\nu}(\cdot), \mathbf{t}(\cdot), \beta(\cdot))$ is called regular if the support of each member of the family does not depend upon the value of the parameter $\boldsymbol{\theta}$.*

Another form of exponential families that deserves a special name is when the density of each member of the family depends linearly on the parameters, i.e., $\boldsymbol{\nu}(\boldsymbol{\theta}) = [\theta_1, \dots, \theta_k]$.

Definition 2.2.3. *A canonical exponential family is one which depends linearly on the parameter $\boldsymbol{\theta}$:*

$$p(\mathbf{y}|\boldsymbol{\theta}) = \exp \left\{ \boldsymbol{\theta}^\top \mathbf{t} - \alpha(\boldsymbol{\theta}) + \beta(\mathbf{y}) \right\} \quad (2.13)$$

$$= \exp \left\{ \sum_{i=1}^k \theta_i t_i(\mathbf{y}) - \alpha(\boldsymbol{\theta}) + \beta(\mathbf{y}) \right\}. \quad (2.14)$$

We will denote the canonical exponential family by $\epsilon(\boldsymbol{\theta}; \mathbf{I}(\cdot), \mathbf{t}(\cdot), \beta(\cdot))$

One, in theory, can describe the canonical exp. family form by defining a family \mathcal{P}_η with the parameters as the possibly nonlinear mapping \dots . In practice, it might be challenging to find the set of admissible values of $\boldsymbol{\eta}$ and the form of the log-partition function. Note that some references, such as Bernardo and Smith [15], use the term *canonical* to refer to exp. families that also depend linearly on the data.

Definition 2.2.4. *For data \mathbf{y} distributed according to $p(\mathbf{y}|\boldsymbol{\theta})$, a parameter $\boldsymbol{\theta}$ is termed unidentifiable on the basis of \mathbf{y} if there exists $\boldsymbol{\theta}_1 \neq \boldsymbol{\theta}_2$ such that $\mathbf{P}_{\boldsymbol{\theta}_1} = \mathbf{P}_{\boldsymbol{\theta}_2}$.*

2.2.1 Properties of the Canonical Exponential Family

2.2.2 Interpretation as Linearly Constrained Maximum Entropy Distribution

2.2.3 Examples

2.3 Sufficient Statistics

For the exponential family, we have seen that the densities only depend on the data through the natural statistics $\mathbf{t}(\mathbf{y})$ and the base distributions $q(\mathbf{y}) \propto \exp\{\beta(\mathbf{y})\}$.

This leads one to ask under what conditions are inferences using transformations of the data, or *statistics*, the same as if we had used the data itself. One might additionally ask what set of models yield a compact set of statistics, summarizing an arbitrarily large set of data, that are sufficient for the inferences we wish to make. In the following, we establish a formal framework for this data-processing concept.

Definition 2.3.1. *Given a sequence of random variables $\mathbf{y}_1, \mathbf{y}_2, \dots$, with $\mathbf{y}_j \in \mathcal{Y}_j$ and probability measure P , a sequence of statistics $\mathbf{t}_1, \mathbf{t}_2, \dots$, with each function \mathbf{t}_j defined on the product space $\mathcal{Y}_1 \times \dots \times \mathcal{Y}_j$, is said to be predictive sufficient for $\mathbf{y}_1, \mathbf{y}_2, \dots$ if*

$$p(\mathbf{y}_{i_1}, \dots, \mathbf{y}_{i_k} | \mathbf{y}_1, \dots, \mathbf{y}_j) = p(\mathbf{y}_{i_1}, \dots, \mathbf{y}_{i_k} | \mathbf{t}_j) \quad \forall j, k \quad (2.15)$$

where $\{i_1, \dots, i_k\}$ are a set of indices not seen in $\{1, \dots, j\}$. Here, $p(\cdot | \cdot)$ is the conditional density induced by the measure P .

That is, given $\mathbf{t}_j = \mathbf{t}_j(\mathbf{y}_1, \dots, \mathbf{y}_j)$, the values of the data $\mathbf{y}_1, \dots, \mathbf{y}_j$ do not further contribute to the prediction of future values of data.

2.4 Incorporating Prior Knowledge

2.4.1 Conjugate Priors

2.4.2 Multinomial Observations

2.4.3 Gaussian Observations

2.4.4 Multivariate Linear Regression Model

2.5 Graphical Models

2.5.1 A Brief Overview

2.5.2 Directed Graphical Models

2.5.3 Undirected Graphical Models

2.5.4 Belief Propagation

2.6 Hidden Markov Model

2.6.1 Forward-Backward Algorithm

2.6.2 Viterbi Algorithm

2.7 State Space Models

2.7.1 Standard Discrete-Time Linear-Gaussian State Space Formulation

2.7.2 Vector Autoregressive Processes

2.7.3 Switching Linear Dynamic Systems

2.7.4 Stochastic Realization Theory

2.7.5 Kalman Filtering and Smoothing

2.8 Markov Chain Monte Carlo

2.8.1 Monte Carlo Integration

2.8.2 The Metropolis-Hastings Algorithm

2.8.3 Gibbs Sampling

2.8.4 Auxiliary, Blocked, and Collapsed Gibbs Samplers

Route/Trajectory Prediction

3.1 Section

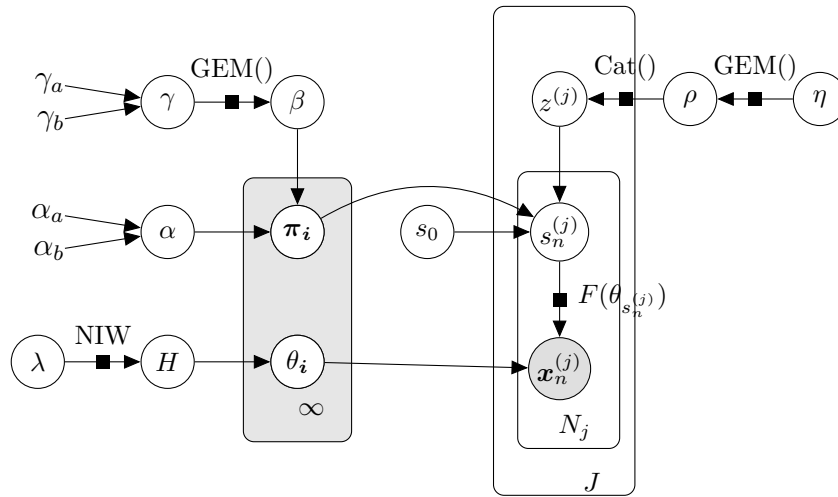

$$\mathbf{i} = [l, k] \tag{3.1}$$

l represents the l 'th HMM (e.g. for trajectory classification) and state k respectively.

3.1.1 Subsection

Prediction of driver influenced parameter (velocity and longitudinal and lateral acceleration)

4.1 Section

4.1.1 Subsection

Fifth Chapter

5.1 Section

5.1.1 Subsection

Conclusion

6.1 Section

6.1.1 Subsection

Test Chapter

Templates, Tests, Rests

7.1 ToDo's

- Nomenclature + Macros + Symbols with heads + Tabel Format (Emily Fox)
- All compiling
- Fast compiling
- Bibliography
- Kopf- bzw. Fußzeile bei:
 - Notational Conventions
 - Acronyms and Abbreviations
 - Contents
 - List of Figures
 - List of Tables
 - Bibliography
 - MAIN Part ...

Afterwards

- Declaration?
- Titelseite anpassen
- Bisher keine Links bei refs auf Subfigures (subcaptionbox in chapter static Varianten Normalisierung)

- Spacing in Math Mode aus The Not so Short Introduction to Latex 2e
- Umbrüche / zu lange Zeilen / Hyphenation prüfen
- Prüfen: überall log (englisch) statt ln (deutsch)?

Ganz zum Schluss, in dieser Reihenfolge:

1. Literaturverzeichnis prüfen
2. Text nach ?? durchsuchen
3. Boxen prüfen
4. Worttrennung / Umbrüche prüfen
5. Platzierung von Algorithmen prüfen
6. Literatur ausdrucken

7.2 Notes

Notizen:

-
-
-
-
-
-

7.3 FixMe

- To Do
- Fix me
- Fix me - no text
- Caution
- Info

7.4 Cite

- [1]
- [2]
- [3, p. 14]
- [4, p. 491]
- [4, pp. 31 sq.]
- [5, pp. 411–417]

7.5 Glossaries

Glossaries (GLS)

- Mean-squared-Error (MSE)
- i.i.d.s

7.6 Reference

- Appendix: `\appref{app:xxx}`
- Tabular: `\tabref{tab:xxx}`
- Equation: `\eqref{eq:xxx}`
- Figure: `\figref{fig:xxx}`

7.7 Macros

7.7.1 Equations

$$a^2 + b^2 = 7c^2 \tag{7.1}$$

$$\mathbf{y} = \mathbf{Ax} \tag{7.2}$$

$$\mathbf{R}_x(\theta) = \begin{bmatrix} 1 & 0 & 0 \\ 0 & \cos(\theta) & -\sin(\theta) \\ 0 & \sin(\theta) & \cos(\theta) \end{bmatrix} \quad (7.3a)$$

$$\mathbf{R}_z(\theta) = \begin{bmatrix} \cos(\theta) & -\sin(\theta) & 0 \\ \sin(\theta) & \cos(\theta) & 0 \\ 0 & 0 & 1 \end{bmatrix} \quad (7.3b)$$

$${}^A \mathbf{R}_A(\boldsymbol{\xi}) = \mathbf{R}_z(\phi) \mathbf{R}_{x'}(\vartheta) \mathbf{R}_{z''}(\psi) = \begin{bmatrix} A\mathbf{e}_x & A\mathbf{e}_y & A\mathbf{e}_z \end{bmatrix} \quad (7.4)$$

7.7.2 Function

Maktros ... ${}^O \mathbf{r} \in \mathbb{R}^3$ und ${}^A \mathbf{r} \in \mathbb{R}^3$, $\mathbf{R}_x(\theta)$, $\mathbf{R}_y(\theta)$ und $\mathbf{R}_z(\theta)$

7.8 Table

Table 7.1: Bla Bla

DH-Parameter	θ [rad]	d [mm]	a [mm]	α [rad]
Basis	0	40	0	0
Achse 1	q_1	0	l_1	0
Achse 2	q_2	0	l_2	0
Achse 3	0	$q_3 - 40$	0	0
Achse 4	q_4	0	xxx	$-\pi/2$
Achse 5	q_5	0	xxx	0

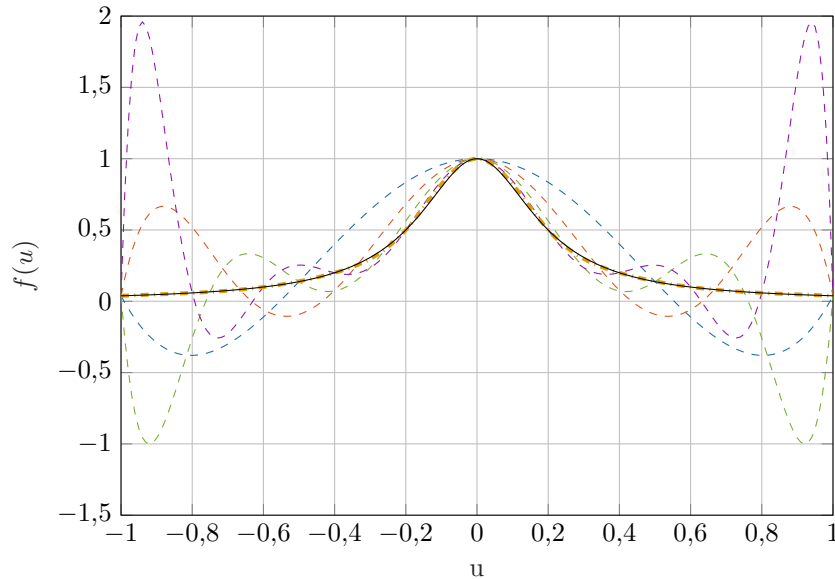

Figure 7.2: Funktion $f(u) = \frac{1}{25u^2+1}$ (—) und deren Polynominterpolation nach ; Polynom vom Grad $\nu = 4$ (---), Grad $\nu = 6$ (---), Grad $\nu = 8$ (---) und Grad $\nu = 10$ (---), sowie eine kubische Splineinterpolation (---) durch 10 Segmente

7.9 Figures

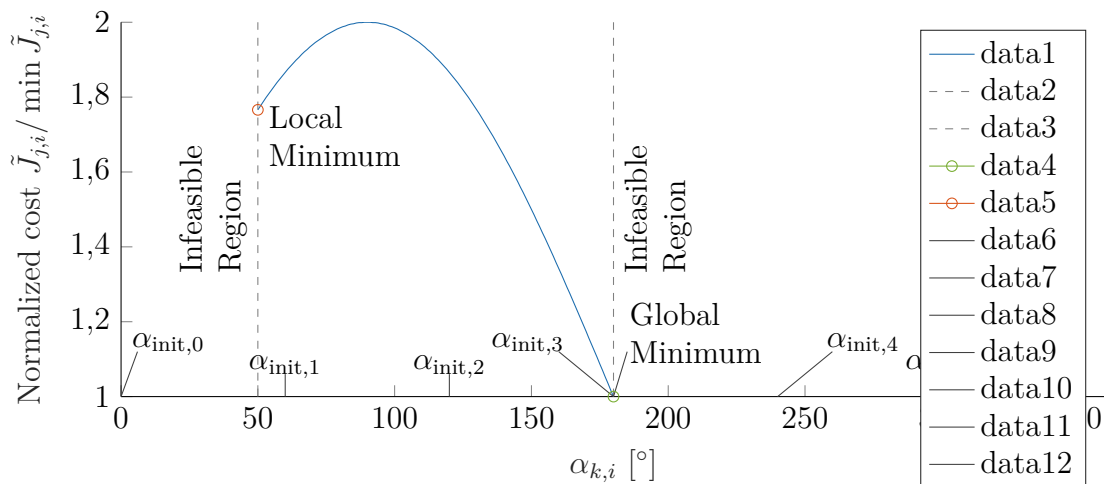
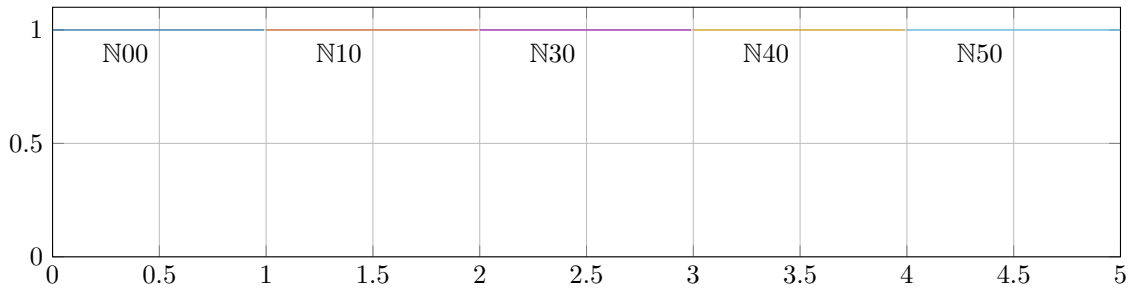
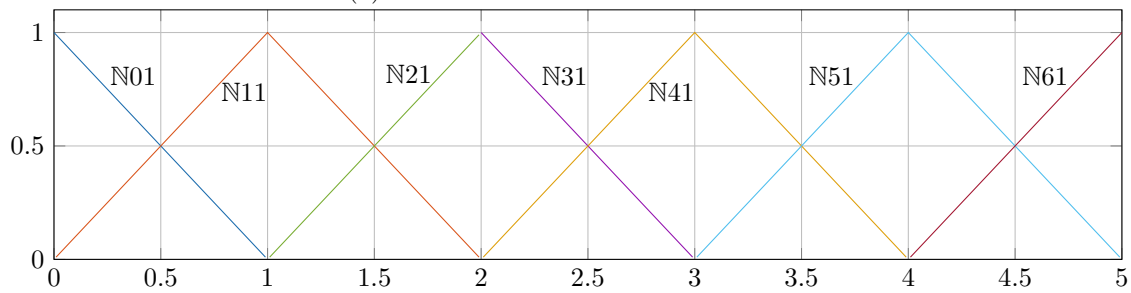

Figure 7.1: Testplot

Lorem ipsum dolor sit amet, consectetur adipiscing elit. Etiam lobortis facilisis sem. Nullam nec mi et neque pharetra sollicitudin. Praesent imperdiet mi nec ante. Donec ullamcorper, felis non sodales commodo, lectus velit ultrices augue, a dignissim nibh lectus placerat pede. Vivamus nunc nunc, molestie ut, ultricies vel, semper in, velit. Ut porttitor. Praesent in sapien. Lorem ipsum dolor sit amet, consectetur adipiscing elit. Duis fringilla tristique neque. Sed interdum libero ut metus. Pellentesque placerat. Nam rutrum augue a leo. Morbi sed elit sit amet ante lobortis sollicitudin. Praesent blandit blandit mauris. Praesent



(a) Basisfunktionen nullten Grades



(b) Basisfunktionen ersten Grades

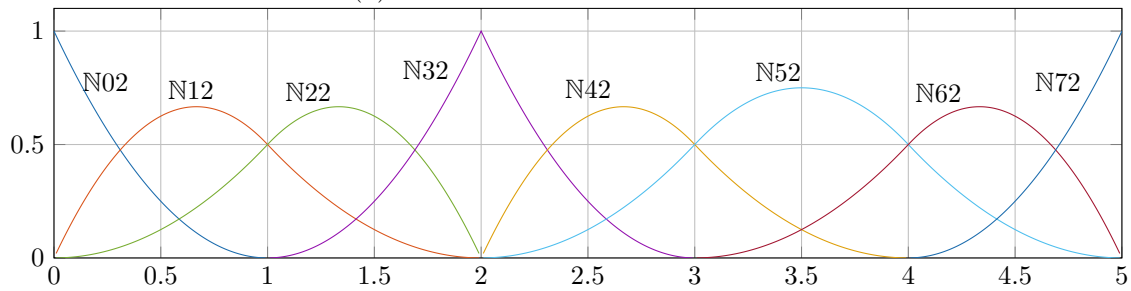

(c) Basisfunktionen zweiten Grades

Figure 7.3: Basisfunktionen definiert mit dem Knotenvektor

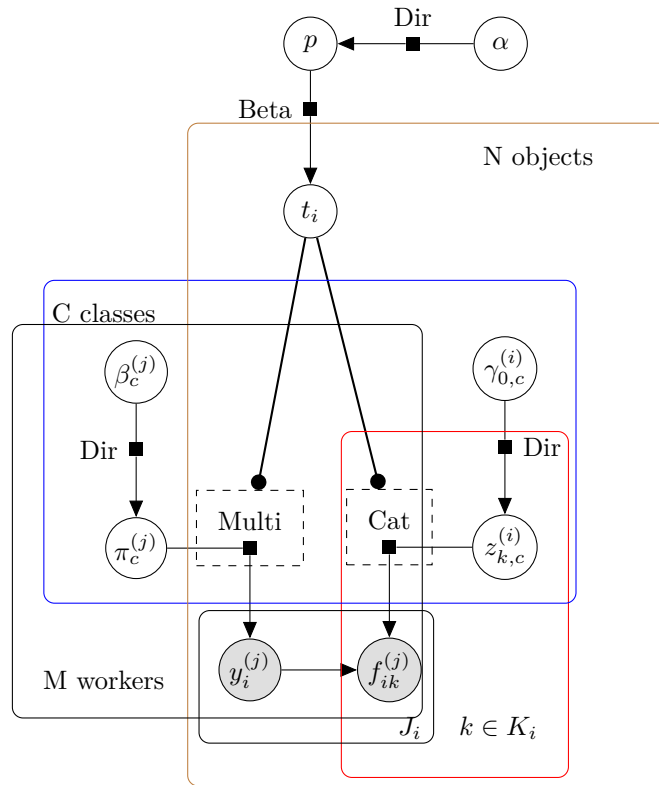

lectus tellus, aliquet aliquam, luctus a, egestas a, turpis. Mauris lacinia lorem sit amet ipsum. Nunc quis urna dictum turpis accumsan semper. Lorem ipsum dolor sit amet, consectetur adipiscing elit. Etiam lobortis facilisis sem. Nullam nec mi et neque pharetra sollicitudin. Praesent imperdiet mi nec ante. Donec ullamcorper, felis non sodales commodo, lectus velit ultrices augue, a dignissim nibh lectus placerat pede. Vivamus nunc nunc, molestie ut, ultricies vel, semper in, velit. Ut porttitor. Praesent in sapien. Lorem ipsum dolor sit amet, consectetur adipiscing elit. Duis fringilla tristique neque. Sed interdum libero ut metus. Pellentesque placerat. Nam rutrum augue a leo. Morbi sed elit sit amet ante lobortis sollicitudin. Praesent blandit blandit mauris. Praesent lectus tellus, aliquet aliquam, luctus a, egestas a, turpis. Mauris lacinia lorem sit amet ipsum. Nunc quis urna dictum turpis accumsan semper.

Lorem ipsum dolor sit amet, consectetur adipiscing elit. Etiam lobortis facilisis sem. Nullam nec mi et neque pharetra sollicitudin. Praesent imperdiet mi nec ante. Donec ullamcorper, felis non sodales commodo, lectus velit ultrices augue, a dignissim nibh lectus placerat pede. Vivamus nunc nunc, molestie ut, ultricies vel, semper in, velit. Ut porttitor. Praesent in sapien. Lorem ipsum dolor sit amet, consectetur adipiscing elit. Duis fringilla tristique neque. Sed interdum libero ut metus. Pellentesque placerat. Nam rutrum augue a leo. Morbi sed elit sit amet ante lobortis sollicitudin. Praesent blandit blandit mauris. Praesent lectus tellus, aliquet aliquam, luctus a, egestas a, turpis. Mauris lacinia lorem sit amet ipsum. Nunc quis urna dictum turpis accumsan semper.

Lorem ipsum dolor sit amet, consectetur adipiscing elit. Etiam lobortis facilisis sem. Nullam nec mi et neque pharetra sollicitudin. Praesent imperdiet mi nec ante. Donec ullamcorper, felis non sodales commodo, lectus velit ultrices augue, a dignissim nibh lectus placerat pede. Vivamus nunc nunc, molestie ut, ultricies vel, semper in, velit. Ut porttitor. Praesent in sapien. Lorem ipsum dolor sit amet, consectetur adipiscing elit. Duis fringilla tristique neque. Sed interdum libero ut metus. Pellentesque placerat. Nam rutrum augue a leo. Morbi sed elit sit amet ante lobortis sollicitudin. Praesent blandit blandit mauris. Praesent lectus tellus, aliquet aliquam, luctus a, egestas a, turpis. Mauris lacinia lorem sit amet ipsum. Nunc quis urna dictum turpis accumsan semper.

Lorem ipsum dolor sit amet, consectetur adipiscing elit. Etiam lobortis facilisis sem. Nullam nec mi et neque pharetra sollicitudin. Praesent imperdiet mi nec ante. Donec ullamcorper, felis non sodales commodo, lectus velit ultrices augue, a dignissim nibh lectus placerat pede. Vivamus nunc nunc, molestie ut, ultricies vel, semper in, velit. Ut porttitor. Praesent in sapien. Lorem ipsum dolor sit amet, consectetur adipiscing elit. Duis fringilla tristique neque. Sed interdum libero ut metus. Pellentesque placerat. Nam rutrum augue a leo. Morbi sed elit sit amet ante lobortis sollicitudin. Praesent blandit blandit mauris. Praesent lectus tellus, aliquet aliquam, luctus a, egestas a, turpis. Mauris lacinia lorem sit amet ipsum. Nunc quis urna dictum turpis accumsan semper.

Lorem ipsum dolor sit amet, consectetur adipiscing elit. Etiam lobortis facilisis sem. Nullam nec mi et neque pharetra sollicitudin. Praesent imperdiet mi nec ante. Donec ullamcorper, felis non sodales commodo, lectus velit ultrices augue, a dignissim nibh lectus placerat pede. Vivamus nunc nunc, molestie ut, ultricies vel, semper in, velit. Ut porttitor. Praesent in sapien. Lorem ipsum dolor sit amet, consectetur adipiscing elit. Duis fringilla tristique neque. Sed interdum libero ut metus. Pellentesque placerat. Nam rutrum augue a leo. Morbi sed elit sit amet ante lobortis sollicitudin. Praesent blandit blandit mauris. Praesent lectus tellus, aliquet aliquam, luctus a, egestas a, turpis. Mauris lacinia lorem sit amet ipsum. Nunc quis urna dictum turpis accumsan semper.

Heading on level 0 (chapter)

Lorem ipsum dolor sit amet, consectetur adipiscing elit. Etiam lobortis facilisis sem. Nullam nec mi et neque pharetra sollicitudin. Praesent imperdiet mi nec ante. Donec ullamcorper, felis non sodales commodo, lectus velit ultrices augue, a dignissim nibh lectus placerat pede. Vivamus nunc nunc, molestie ut, ultricies vel, semper in, velit. Ut porttitor. Praesent in sapien. Lorem ipsum dolor sit amet, consectetur adipiscing elit. Duis fringilla tristique neque. Sed interdum libero ut metus. Pellentesque placerat. Nam rutrum augue a leo. Morbi sed elit sit amet ante lobortis sollicitudin. Praesent blandit blandit mauris. Praesent lectus tellus, aliquet aliquam, luctus a, egestas a, turpis. Mauris lacinia lorem sit amet ipsum. Nunc quis urna dictum turpis accumsan semper.

8.1 Heading on level 1 (section)

Lorem ipsum dolor sit amet, consectetur adipiscing elit. Etiam lobortis facilisis sem. Nullam nec mi et neque pharetra sollicitudin. Praesent imperdiet mi nec ante. Donec ullamcorper, felis non sodales commodo, lectus velit ultrices augue, a dignissim nibh lectus placerat pede. Vivamus nunc nunc, molestie ut, ultricies vel, semper in, velit. Ut porttitor. Praesent in sapien. Lorem ipsum dolor sit amet, consectetur adipiscing elit. Duis fringilla tristique neque. Sed interdum libero ut metus. Pellentesque placerat. Nam rutrum augue a leo. Morbi sed elit sit amet ante lobortis sollicitudin. Praesent blandit blandit mauris. Praesent lectus tellus, aliquet aliquam, luctus a, egestas a, turpis. Mauris lacinia lorem sit amet ipsum. Nunc quis urna dictum turpis accumsan semper.

8.1.1 Heading on level 2 (subsection)

Lorem ipsum dolor sit amet, consectetur adipiscing elit. Etiam lobortis facilisis sem. Nullam nec mi et neque pharetra sollicitudin. Praesent imperdiet mi nec ante. Donec ullamcorper, felis non sodales commodo, lectus velit ultrices augue, a dignissim nibh lectus placerat pede. Vivamus nunc nunc, molestie ut, ultricies vel, semper in, velit. Ut porttitor. Praesent in sapien. Lorem ipsum dolor sit amet, consectetur adipiscing elit. Duis fringilla tristique

neque. Sed interdum libero ut metus. Pellentesque placerat. Nam rutrum augue a leo. Morbi sed elit sit amet ante lobortis sollicitudin. Praesent blandit blandit mauris. Praesent lectus tellus, aliquet aliquam, luctus a, egestas a, turpis. Mauris lacinia lorem sit amet ipsum. Nunc quis urna dictum turpis accumsan semper.

Heading on level 3 (subsubsection)

Lorem ipsum dolor sit amet, consectetur adipiscing elit. Etiam lobortis facilisis sem. Nullam nec mi et neque pharetra sollicitudin. Praesent imperdiet mi nec ante. Donec ullamcorper, felis non sodales commodo, lectus velit ultrices augue, a dignissim nibh lectus placerat pede. Vivamus nunc nunc, molestie ut, ultricies vel, semper in, velit. Ut porttitor. Praesent in sapien. Lorem ipsum dolor sit amet, consectetur adipiscing elit. Duis fringilla tristique neque. Sed interdum libero ut metus. Pellentesque placerat. Nam rutrum augue a leo. Morbi sed elit sit amet ante lobortis sollicitudin. Praesent blandit blandit mauris. Praesent lectus tellus, aliquet aliquam, luctus a, egestas a, turpis. Mauris lacinia lorem sit amet ipsum. Nunc quis urna dictum turpis accumsan semper.

Heading on level 4 (paragraph) Lorem ipsum dolor sit amet, consectetur adipiscing elit. Etiam lobortis facilisis sem. Nullam nec mi et neque pharetra sollicitudin. Praesent imperdiet mi nec ante. Donec ullamcorper, felis non sodales commodo, lectus velit ultrices augue, a dignissim nibh lectus placerat pede. Vivamus nunc nunc, molestie ut, ultricies vel, semper in, velit. Ut porttitor. Praesent in sapien. Lorem ipsum dolor sit amet, consectetur adipiscing elit. Duis fringilla tristique neque. Sed interdum libero ut metus. Pellentesque placerat. Nam rutrum augue a leo. Morbi sed elit sit amet ante lobortis sollicitudin. Praesent blandit blandit mauris. Praesent lectus tellus, aliquet aliquam, luctus a, egestas a, turpis. Mauris lacinia lorem sit amet ipsum. Nunc quis urna dictum turpis accumsan semper.

8.2 Lists

8.2.1 Example for list (itemize)

- First itemtext
- Second itemtext
- Last itemtext
- First itemtext
- Second itemtext

Example for list (4*itemize)

- First itemtext
 - First itemtext
 - * First itemtext
 - First itemtext
 - Second itemtext
 - * Last itemtext
 - First itemtext
- Second itemtext

8.2.2 Example for list (enumerate)

1. First itemtext
2. Second itemtext
3. Last itemtext
4. First itemtext
5. Second itemtext

Example for list (4*enumerate)

1. First itemtext
 - a) First itemtext
 - i. First itemtext
 - A. First itemtext
 - B. Second itemtext
 - ii. Last itemtext
 - b) First itemtext
2. Second itemtext

8.2.3 Example for list (description)

First itemtext

Second itemtext

Last itemtext

First itemtext

Second itemtext

Example for list (4*description)

First itemtext

First itemtext

First itemtext

First itemtext

Second itemtext

Last itemtext

First itemtext

Second itemtext

Heading on level 0 (chapter)

Lorem ipsum dolor sit amet, consectetur adipiscing elit. Etiam lobortis facilisis sem. Nullam nec mi et neque pharetra sollicitudin. Praesent imperdiet mi nec ante. Donec ullamcorper, felis non sodales commodo, lectus velit ultrices augue, a dignissim nibh lectus placerat pede. Vivamus nunc nunc, molestie ut, ultricies vel, semper in, velit. Ut porttitor. Praesent in sapien. Lorem ipsum dolor sit amet, consectetur adipiscing elit. Duis fringilla tristique neque. Sed interdum libero ut metus. Pellentesque placerat. Nam rutrum augue a leo. Morbi sed elit sit amet ante lobortis sollicitudin. Praesent blandit blandit mauris. Praesent lectus tellus, aliquet aliquam, luctus a, egestas a, turpis. Mauris lacinia lorem sit amet ipsum. Nunc quis urna dictum turpis accumsan semper.

9.1 Heading on level 1 (section)

Lorem ipsum dolor sit amet, consectetur adipiscing elit. Etiam lobortis facilisis sem. Nullam nec mi et neque pharetra sollicitudin. Praesent imperdiet mi nec ante. Donec ullamcorper, felis non sodales commodo, lectus velit ultrices augue, a dignissim nibh lectus placerat pede. Vivamus nunc nunc, molestie ut, ultricies vel, semper in, velit. Ut porttitor. Praesent in sapien. Lorem ipsum dolor sit amet, consectetur adipiscing elit. Duis fringilla tristique neque. Sed interdum libero ut metus. Pellentesque placerat. Nam rutrum augue a leo. Morbi sed elit sit amet ante lobortis sollicitudin. Praesent blandit blandit mauris. Praesent lectus tellus, aliquet aliquam, luctus a, egestas a, turpis. Mauris lacinia lorem sit amet ipsum. Nunc quis urna dictum turpis accumsan semper.

Lorem ipsum dolor sit amet, consectetur adipiscing elit. Etiam lobortis facilisis sem. Nullam nec mi et neque pharetra sollicitudin. Praesent imperdiet mi nec ante. Donec ullamcorper, felis non sodales commodo, lectus velit ultrices augue, a dignissim nibh lectus placerat pede. Vivamus nunc nunc, molestie ut, ultricies vel, semper in, velit. Ut porttitor. Praesent in sapien. Lorem ipsum dolor sit amet, consectetur adipiscing elit. Duis fringilla tristique neque. Sed interdum libero ut metus. Pellentesque placerat. Nam rutrum augue a leo. Morbi sed elit sit amet ante lobortis sollicitudin. Praesent blandit blandit mauris. Praesent lectus tellus, aliquet aliquam, luctus a, egestas a, turpis. Mauris lacinia lorem sit

amet ipsum. Nunc quis urna dictum turpis accumsan semper.

Lorem ipsum dolor sit amet, consectetur adipiscing elit. Etiam lobortis facilisis sem. Nullam nec mi et neque pharetra sollicitudin. Praesent imperdiet mi nec ante. Donec ullamcorper, felis non sodales commodo, lectus velit ultrices augue, a dignissim nibh lectus placerat pede. Vivamus nunc nunc, molestie ut, ultricies vel, semper in, velit. Ut porttitor. Praesent in sapien. Lorem ipsum dolor sit amet, consectetur adipiscing elit. Duis fringilla tristique neque. Sed interdum libero ut metus. Pellentesque placerat. Nam rutrum augue a leo. Morbi sed elit sit amet ante lobortis sollicitudin. Praesent blandit blandit mauris. Praesent lectus tellus, aliquet aliquam, luctus a, egestas a, turpis. Mauris lacinia lorem sit amet ipsum. Nunc quis urna dictum turpis accumsan semper.

Lorem ipsum dolor sit amet, consectetur adipiscing elit. Etiam lobortis facilisis sem. Nullam nec mi et neque pharetra sollicitudin. Praesent imperdiet mi nec ante. Donec ullamcorper, felis non sodales commodo, lectus velit ultrices augue, a dignissim nibh lectus placerat pede. Vivamus nunc nunc, molestie ut, ultricies vel, semper in, velit. Ut porttitor. Praesent in sapien. Lorem ipsum dolor sit amet, consectetur adipiscing elit. Duis fringilla tristique neque. Sed interdum libero ut metus. Pellentesque placerat. Nam rutrum augue a leo. Morbi sed elit sit amet ante lobortis sollicitudin. Praesent blandit blandit mauris. Praesent lectus tellus, aliquet aliquam, luctus a, egestas a, turpis. Mauris lacinia lorem sit amet ipsum. Nunc quis urna dictum turpis accumsan semper.

Lorem ipsum dolor sit amet, consectetur adipiscing elit. Etiam lobortis facilisis sem. Nullam nec mi et neque pharetra sollicitudin. Praesent imperdiet mi nec ante. Donec ullamcorper, felis non sodales commodo, lectus velit ultrices augue, a dignissim nibh lectus placerat pede. Vivamus nunc nunc, molestie ut, ultricies vel, semper in, velit. Ut porttitor. Praesent in sapien. Lorem ipsum dolor sit amet, consectetur adipiscing elit. Duis fringilla tristique neque. Sed interdum libero ut metus. Pellentesque placerat. Nam rutrum augue a leo. Morbi sed elit sit amet ante lobortis sollicitudin. Praesent blandit blandit mauris. Praesent lectus tellus, aliquet aliquam, luctus a, egestas a, turpis. Mauris lacinia lorem sit amet ipsum. Nunc quis urna dictum turpis accumsan semper.

9.1.1 Heading on level 2 (subsection)

Lorem ipsum dolor sit amet, consectetur adipiscing elit. Etiam lobortis facilisis sem. Nullam nec mi et neque pharetra sollicitudin. Praesent imperdiet mi nec ante. Donec ullamcorper, felis non sodales commodo, lectus velit ultrices augue, a dignissim nibh lectus placerat pede. Vivamus nunc nunc, molestie ut, ultricies vel, semper in, velit. Ut porttitor. Praesent in sapien. Lorem ipsum dolor sit amet, consectetur adipiscing elit. Duis fringilla tristique neque. Sed interdum libero ut metus. Pellentesque placerat. Nam rutrum augue a leo. Morbi sed elit sit amet ante lobortis sollicitudin. Praesent blandit blandit mauris. Praesent lectus tellus, aliquet aliquam, luctus a, egestas a, turpis. Mauris lacinia lorem sit amet

ipsum. Nunc quis urna dictum turpis accumsan semper.

Lorem ipsum dolor sit amet, consectetur adipiscing elit. Etiam lobortis facilisis sem. Nullam nec mi et neque pharetra sollicitudin. Praesent imperdiet mi nec ante. Donec ullamcorper, felis non sodales commodo, lectus velit ultrices augue, a dignissim nibh lectus placerat pede. Vivamus nunc nunc, molestie ut, ultricies vel, semper in, velit. Ut porttitor. Praesent in sapien. Lorem ipsum dolor sit amet, consectetur adipiscing elit. Duis fringilla tristique neque. Sed interdum libero ut metus. Pellentesque placerat. Nam rutrum augue a leo. Morbi sed elit sit amet ante lobortis sollicitudin. Praesent blandit blandit mauris. Praesent lectus tellus, aliquet aliquam, luctus a, egestas a, turpis. Mauris lacinia lorem sit amet ipsum. Nunc quis urna dictum turpis accumsan semper.

Lorem ipsum dolor sit amet, consectetur adipiscing elit. Etiam lobortis facilisis sem. Nullam nec mi et neque pharetra sollicitudin. Praesent imperdiet mi nec ante. Donec ullamcorper, felis non sodales commodo, lectus velit ultrices augue, a dignissim nibh lectus placerat pede. Vivamus nunc nunc, molestie ut, ultricies vel, semper in, velit. Ut porttitor. Praesent in sapien. Lorem ipsum dolor sit amet, consectetur adipiscing elit. Duis fringilla tristique neque. Sed interdum libero ut metus. Pellentesque placerat. Nam rutrum augue a leo. Morbi sed elit sit amet ante lobortis sollicitudin. Praesent blandit blandit mauris. Praesent lectus tellus, aliquet aliquam, luctus a, egestas a, turpis. Mauris lacinia lorem sit amet ipsum. Nunc quis urna dictum turpis accumsan semper.

Lorem ipsum dolor sit amet, consectetur adipiscing elit. Etiam lobortis facilisis sem. Nullam nec mi et neque pharetra sollicitudin. Praesent imperdiet mi nec ante. Donec ullamcorper, felis non sodales commodo, lectus velit ultrices augue, a dignissim nibh lectus placerat pede. Vivamus nunc nunc, molestie ut, ultricies vel, semper in, velit. Ut porttitor. Praesent in sapien. Lorem ipsum dolor sit amet, consectetur adipiscing elit. Duis fringilla tristique neque. Sed interdum libero ut metus. Pellentesque placerat. Nam rutrum augue a leo. Morbi sed elit sit amet ante lobortis sollicitudin. Praesent blandit blandit mauris. Praesent lectus tellus, aliquet aliquam, luctus a, egestas a, turpis. Mauris lacinia lorem sit amet ipsum. Nunc quis urna dictum turpis accumsan semper.

Lorem ipsum dolor sit amet, consectetur adipiscing elit. Etiam lobortis facilisis sem. Nullam nec mi et neque pharetra sollicitudin. Praesent imperdiet mi nec ante. Donec ullamcorper, felis non sodales commodo, lectus velit ultrices augue, a dignissim nibh lectus placerat pede. Vivamus nunc nunc, molestie ut, ultricies vel, semper in, velit. Ut porttitor. Praesent in sapien. Lorem ipsum dolor sit amet, consectetur adipiscing elit. Duis fringilla tristique neque. Sed interdum libero ut metus. Pellentesque placerat. Nam rutrum augue a leo. Morbi sed elit sit amet ante lobortis sollicitudin. Praesent blandit blandit mauris. Praesent lectus tellus, aliquet aliquam, luctus a, egestas a, turpis. Mauris lacinia lorem sit amet ipsum. Nunc quis urna dictum turpis accumsan semper.

Heading on level 3 (subsection)

Lorem ipsum dolor sit amet, consectetur adipiscing elit. Etiam lobortis facilisis sem. Nullam nec mi et neque pharetra sollicitudin. Praesent imperdiet mi nec ante. Donec ullamcorper, felis non sodales commodo, lectus velit ultrices augue, a dignissim nibh lectus placerat pede. Vivamus nunc nunc, molestie ut, ultricies vel, semper in, velit. Ut porttitor. Praesent in sapien. Lorem ipsum dolor sit amet, consectetur adipiscing elit. Duis fringilla tristique neque. Sed interdum libero ut metus. Pellentesque placerat. Nam rutrum augue a leo. Morbi sed elit sit amet ante lobortis sollicitudin. Praesent blandit blandit mauris. Praesent lectus tellus, aliquet aliquam, luctus a, egestas a, turpis. Mauris lacinia lorem sit amet ipsum. Nunc quis urna dictum turpis accumsan semper.

Lorem ipsum dolor sit amet, consectetur adipiscing elit. Etiam lobortis facilisis sem. Nullam nec mi et neque pharetra sollicitudin. Praesent imperdiet mi nec ante. Donec ullamcorper, felis non sodales commodo, lectus velit ultrices augue, a dignissim nibh lectus placerat pede. Vivamus nunc nunc, molestie ut, ultricies vel, semper in, velit. Ut porttitor. Praesent in sapien. Lorem ipsum dolor sit amet, consectetur adipiscing elit. Duis fringilla tristique neque. Sed interdum libero ut metus. Pellentesque placerat. Nam rutrum augue a leo. Morbi sed elit sit amet ante lobortis sollicitudin. Praesent blandit blandit mauris. Praesent lectus tellus, aliquet aliquam, luctus a, egestas a, turpis. Mauris lacinia lorem sit amet ipsum. Nunc quis urna dictum turpis accumsan semper.

Lorem ipsum dolor sit amet, consectetur adipiscing elit. Etiam lobortis facilisis sem. Nullam nec mi et neque pharetra sollicitudin. Praesent imperdiet mi nec ante. Donec ullamcorper, felis non sodales commodo, lectus velit ultrices augue, a dignissim nibh lectus placerat pede. Vivamus nunc nunc, molestie ut, ultricies vel, semper in, velit. Ut porttitor. Praesent in sapien. Lorem ipsum dolor sit amet, consectetur adipiscing elit. Duis fringilla tristique neque. Sed interdum libero ut metus. Pellentesque placerat. Nam rutrum augue a leo. Morbi sed elit sit amet ante lobortis sollicitudin. Praesent blandit blandit mauris. Praesent lectus tellus, aliquet aliquam, luctus a, egestas a, turpis. Mauris lacinia lorem sit amet ipsum. Nunc quis urna dictum turpis accumsan semper.

Lorem ipsum dolor sit amet, consectetur adipiscing elit. Etiam lobortis facilisis sem. Nullam nec mi et neque pharetra sollicitudin. Praesent imperdiet mi nec ante. Donec ullamcorper, felis non sodales commodo, lectus velit ultrices augue, a dignissim nibh lectus placerat pede. Vivamus nunc nunc, molestie ut, ultricies vel, semper in, velit. Ut porttitor. Praesent in sapien. Lorem ipsum dolor sit amet, consectetur adipiscing elit. Duis fringilla tristique neque. Sed interdum libero ut metus. Pellentesque placerat. Nam rutrum augue a leo. Morbi sed elit sit amet ante lobortis sollicitudin. Praesent blandit blandit mauris. Praesent lectus tellus, aliquet aliquam, luctus a, egestas a, turpis. Mauris lacinia lorem sit amet ipsum. Nunc quis urna dictum turpis accumsan semper.

Lorem ipsum dolor sit amet, consectetur adipiscing elit. Etiam lobortis facilisis sem.

Nullam nec mi et neque pharetra sollicitudin. Praesent imperdiet mi nec ante. Donec ullamcorper, felis non sodales commodo, lectus velit ultrices augue, a dignissim nibh lectus placerat pede. Vivamus nunc nunc, molestie ut, ultricies vel, semper in, velit. Ut porttitor. Praesent in sapien. Lorem ipsum dolor sit amet, consectetur adipiscing elit. Duis fringilla tristique neque. Sed interdum libero ut metus. Pellentesque placerat. Nam rutrum augue a leo. Morbi sed elit sit amet ante lobortis sollicitudin. Praesent blandit blandit mauris. Praesent lectus tellus, aliquet aliquam, luctus a, egestas a, turpis. Mauris lacinia lorem sit amet ipsum. Nunc quis urna dictum turpis accumsan semper.

Heading on level 4 (paragraph) Lorem ipsum dolor sit amet, consectetur adipiscing elit. Etiam lobortis facilisis sem. Nullam nec mi et neque pharetra sollicitudin. Praesent imperdiet mi nec ante. Donec ullamcorper, felis non sodales commodo, lectus velit ultrices augue, a dignissim nibh lectus placerat pede. Vivamus nunc nunc, molestie ut, ultricies vel, semper in, velit. Ut porttitor. Praesent in sapien. Lorem ipsum dolor sit amet, consectetur adipiscing elit. Duis fringilla tristique neque. Sed interdum libero ut metus. Pellentesque placerat. Nam rutrum augue a leo. Morbi sed elit sit amet ante lobortis sollicitudin. Praesent blandit blandit mauris. Praesent lectus tellus, aliquet aliquam, luctus a, egestas a, turpis. Mauris lacinia lorem sit amet ipsum. Nunc quis urna dictum turpis accumsan semper.

Lorem ipsum dolor sit amet, consectetur adipiscing elit. Etiam lobortis facilisis sem. Nullam nec mi et neque pharetra sollicitudin. Praesent imperdiet mi nec ante. Donec ullamcorper, felis non sodales commodo, lectus velit ultrices augue, a dignissim nibh lectus placerat pede. Vivamus nunc nunc, molestie ut, ultricies vel, semper in, velit. Ut porttitor. Praesent in sapien. Lorem ipsum dolor sit amet, consectetur adipiscing elit. Duis fringilla tristique neque. Sed interdum libero ut metus. Pellentesque placerat. Nam rutrum augue a leo. Morbi sed elit sit amet ante lobortis sollicitudin. Praesent blandit blandit mauris. Praesent lectus tellus, aliquet aliquam, luctus a, egestas a, turpis. Mauris lacinia lorem sit amet ipsum. Nunc quis urna dictum turpis accumsan semper.

Lorem ipsum dolor sit amet, consectetur adipiscing elit. Etiam lobortis facilisis sem. Nullam nec mi et neque pharetra sollicitudin. Praesent imperdiet mi nec ante. Donec ullamcorper, felis non sodales commodo, lectus velit ultrices augue, a dignissim nibh lectus placerat pede. Vivamus nunc nunc, molestie ut, ultricies vel, semper in, velit. Ut porttitor. Praesent in sapien. Lorem ipsum dolor sit amet, consectetur adipiscing elit. Duis fringilla tristique neque. Sed interdum libero ut metus. Pellentesque placerat. Nam rutrum augue a leo. Morbi sed elit sit amet ante lobortis sollicitudin. Praesent blandit blandit mauris. Praesent lectus tellus, aliquet aliquam, luctus a, egestas a, turpis. Mauris lacinia lorem sit amet ipsum. Nunc quis urna dictum turpis accumsan semper.

Lorem ipsum dolor sit amet, consectetur adipiscing elit. Etiam lobortis facilisis sem. Nullam nec mi et neque pharetra sollicitudin. Praesent imperdiet mi nec ante. Donec ullamcorper, felis non sodales commodo, lectus velit ultrices augue, a dignissim nibh lectus

placerat pede. Vivamus nunc nunc, molestie ut, ultricies vel, semper in, velit. Ut porttitor. Praesent in sapien. Lorem ipsum dolor sit amet, consectetur adipiscing elit. Duis fringilla tristique neque. Sed interdum libero ut metus. Pellentesque placerat. Nam rutrum augue a leo. Morbi sed elit sit amet ante lobortis sollicitudin. Praesent blandit blandit mauris. Praesent lectus tellus, aliquet aliquam, luctus a, egestas a, turpis. Mauris lacinia lorem sit amet ipsum. Nunc quis urna dictum turpis accumsan semper.

Lorem ipsum dolor sit amet, consectetur adipiscing elit. Etiam lobortis facilisis sem. Nullam nec mi et neque pharetra sollicitudin. Praesent imperdiet mi nec ante. Donec ullamcorper, felis non sodales commodo, lectus velit ultrices augue, a dignissim nibh lectus placerat pede. Vivamus nunc nunc, molestie ut, ultricies vel, semper in, velit. Ut porttitor. Praesent in sapien. Lorem ipsum dolor sit amet, consectetur adipiscing elit. Duis fringilla tristique neque. Sed interdum libero ut metus. Pellentesque placerat. Nam rutrum augue a leo. Morbi sed elit sit amet ante lobortis sollicitudin. Praesent blandit blandit mauris. Praesent lectus tellus, aliquet aliquam, luctus a, egestas a, turpis. Mauris lacinia lorem sit amet ipsum. Nunc quis urna dictum turpis accumsan semper.

9.2 Lists

9.2.1 Example for list (itemize)

- Lorem ipsum dolor sit amet, consectetur adipiscing elit. Etiam lobortis facilisis sem. Nullam nec mi et neque pharetra sollicitudin. Praesent imperdiet mi nec ante. Donec ullamcorper, felis non sodales commodo, lectus velit ultrices augue, a dignissim nibh lectus placerat pede. Vivamus nunc nunc, molestie ut, ultricies vel, semper in, velit. Ut porttitor. Praesent in sapien. Lorem ipsum dolor sit amet, consectetur adipiscing elit. Duis fringilla tristique neque. Sed interdum libero ut metus. Pellentesque placerat. Nam rutrum augue a leo. Morbi sed elit sit amet ante lobortis sollicitudin. Praesent blandit blandit mauris. Praesent lectus tellus, aliquet aliquam, luctus a, egestas a, turpis. Mauris lacinia lorem sit amet ipsum. Nunc quis urna dictum turpis accumsan semper.
- Lorem ipsum dolor sit amet, consectetur adipiscing elit. Etiam lobortis facilisis sem. Nullam nec mi et neque pharetra sollicitudin. Praesent imperdiet mi nec ante. Donec ullamcorper, felis non sodales commodo, lectus velit ultrices augue, a dignissim nibh lectus placerat pede. Vivamus nunc nunc, molestie ut, ultricies vel, semper in, velit. Ut porttitor. Praesent in sapien. Lorem ipsum dolor sit amet, consectetur adipiscing elit. Duis fringilla tristique neque. Sed interdum libero ut metus. Pellentesque placerat. Nam rutrum augue a leo. Morbi sed elit sit amet ante lobortis sollicitudin. Praesent blandit blandit mauris. Praesent lectus tellus, aliquet aliquam, luctus a, egestas a,

turpis. Mauris lacinia lorem sit amet ipsum. Nunc quis urna dictum turpis accumsan semper.

- Lorem ipsum dolor sit amet, consectetur adipiscing elit. Etiam lobortis facilisis sem. Nullam nec mi et neque pharetra sollicitudin. Praesent imperdiet mi nec ante. Donec ullamcorper, felis non sodales commodo, lectus velit ultrices augue, a dignissim nibh lectus placerat pede. Vivamus nunc nunc, molestie ut, ultricies vel, semper in, velit. Ut porttitor. Praesent in sapien. Lorem ipsum dolor sit amet, consectetur adipiscing elit. Duis fringilla tristique neque. Sed interdum libero ut metus. Pellentesque placerat. Nam rutrum augue a leo. Morbi sed elit sit amet ante lobortis sollicitudin. Praesent blandit blandit mauris. Praesent lectus tellus, aliquet aliquam, luctus a, egestas a, turpis. Mauris lacinia lorem sit amet ipsum. Nunc quis urna dictum turpis accumsan semper.
- Lorem ipsum dolor sit amet, consectetur adipiscing elit. Etiam lobortis facilisis sem. Nullam nec mi et neque pharetra sollicitudin. Praesent imperdiet mi nec ante. Donec ullamcorper, felis non sodales commodo, lectus velit ultrices augue, a dignissim nibh lectus placerat pede. Vivamus nunc nunc, molestie ut, ultricies vel, semper in, velit. Ut porttitor. Praesent in sapien. Lorem ipsum dolor sit amet, consectetur adipiscing elit. Duis fringilla tristique neque. Sed interdum libero ut metus. Pellentesque placerat. Nam rutrum augue a leo. Morbi sed elit sit amet ante lobortis sollicitudin. Praesent blandit blandit mauris. Praesent lectus tellus, aliquet aliquam, luctus a, egestas a, turpis. Mauris lacinia lorem sit amet ipsum. Nunc quis urna dictum turpis accumsan semper.
- Lorem ipsum dolor sit amet, consectetur adipiscing elit. Etiam lobortis facilisis sem. Nullam nec mi et neque pharetra sollicitudin. Praesent imperdiet mi nec ante. Donec ullamcorper, felis non sodales commodo, lectus velit ultrices augue, a dignissim nibh lectus placerat pede. Vivamus nunc nunc, molestie ut, ultricies vel, semper in, velit. Ut porttitor. Praesent in sapien. Lorem ipsum dolor sit amet, consectetur adipiscing elit. Duis fringilla tristique neque. Sed interdum libero ut metus. Pellentesque placerat. Nam rutrum augue a leo. Morbi sed elit sit amet ante lobortis sollicitudin. Praesent blandit blandit mauris. Praesent lectus tellus, aliquet aliquam, luctus a, egestas a, turpis. Mauris lacinia lorem sit amet ipsum. Nunc quis urna dictum turpis accumsan semper.

Example for list (4*itemize)

- Lorem ipsum dolor sit amet, consectetur adipiscing elit. Etiam lobortis facilisis sem. Nullam nec mi et neque pharetra sollicitudin. Praesent imperdiet mi nec ante. Donec ullamcorper, felis non sodales commodo, lectus velit ultrices augue, a dignissim nibh

lectus placerat pede. Vivamus nunc nunc, molestie ut, ultricies vel, semper in, velit. Ut porttitor. Praesent in sapien. Lorem ipsum dolor sit amet, consectetur adipiscing elit. Duis fringilla tristique neque. Sed interdum libero ut metus. Pellentesque placerat. Nam rutrum augue a leo. Morbi sed elit sit amet ante lobortis sollicitudin. Praesent blandit blandit mauris. Praesent lectus tellus, aliquet aliquam, luctus a, egestas a, turpis. Mauris lacinia lorem sit amet ipsum. Nunc quis urna dictum turpis accumsan semper.

– Lorem ipsum dolor sit amet, consectetur adipiscing elit. Etiam lobortis facilisis sem. Nullam nec mi et neque pharetra sollicitudin. Praesent imperdiet mi nec ante. Donec ullamcorper, felis non sodales commodo, lectus velit ultrices augue, a dignissim nibh lectus placerat pede. Vivamus nunc nunc, molestie ut, ultricies vel, semper in, velit. Ut porttitor. Praesent in sapien. Lorem ipsum dolor sit amet, consectetur adipiscing elit. Duis fringilla tristique neque. Sed interdum libero ut metus. Pellentesque placerat. Nam rutrum augue a leo. Morbi sed elit sit amet ante lobortis sollicitudin. Praesent blandit blandit mauris. Praesent lectus tellus, aliquet aliquam, luctus a, egestas a, turpis. Mauris lacinia lorem sit amet ipsum. Nunc quis urna dictum turpis accumsan semper.

* Lorem ipsum dolor sit amet, consectetur adipiscing elit. Etiam lobortis facilisis sem. Nullam nec mi et neque pharetra sollicitudin. Praesent imperdiet mi nec ante. Donec ullamcorper, felis non sodales commodo, lectus velit ultrices augue, a dignissim nibh lectus placerat pede. Vivamus nunc nunc, molestie ut, ultricies vel, semper in, velit. Ut porttitor. Praesent in sapien. Lorem ipsum dolor sit amet, consectetur adipiscing elit. Duis fringilla tristique neque. Sed interdum libero ut metus. Pellentesque placerat. Nam rutrum augue a leo. Morbi sed elit sit amet ante lobortis sollicitudin. Praesent blandit blandit mauris. Praesent lectus tellus, aliquet aliquam, luctus a, egestas a, turpis. Mauris lacinia lorem sit amet ipsum. Nunc quis urna dictum turpis accumsan semper.

· Lorem ipsum dolor sit amet, consectetur adipiscing elit. Etiam lobortis facilisis sem. Nullam nec mi et neque pharetra sollicitudin. Praesent imperdiet mi nec ante. Donec ullamcorper, felis non sodales commodo, lectus velit ultrices augue, a dignissim nibh lectus placerat pede. Vivamus nunc nunc, molestie ut, ultricies vel, semper in, velit. Ut porttitor. Praesent in sapien. Lorem ipsum dolor sit amet, consectetur adipiscing elit. Duis fringilla tristique neque. Sed interdum libero ut metus. Pellentesque placerat. Nam rutrum augue a leo. Morbi sed elit sit amet ante lobortis sollicitudin. Praesent blandit blandit mauris. Praesent lectus tellus, aliquet aliquam, luctus a, egestas a, turpis. Mauris lacinia lorem

sit amet ipsum. Nunc quis urna dictum turpis accumsan semper.

- Lorem ipsum dolor sit amet, consectetur adipiscing elit. Etiam lobortis facilisis sem. Nullam nec mi et neque pharetra sollicitudin. Praesent imperdiet mi nec ante. Donec ullamcorper, felis non sodales commodo, lectus velit ultrices augue, a dignissim nibh lectus placerat pede. Vivamus nunc nunc, molestie ut, ultricies vel, semper in, velit. Ut porttitor. Praesent in sapien. Lorem ipsum dolor sit amet, consectetur adipiscing elit. Duis fringilla tristique neque. Sed interdum libero ut metus. Pellentesque placerat. Nam rutrum augue a leo. Morbi sed elit sit amet ante lobortis sollicitudin. Praesent blandit blandit mauris. Praesent lectus tellus, aliquet aliquam, luctus a, egestas a, turpis. Mauris lacinia lorem sit amet ipsum. Nunc quis urna dictum turpis accumsan semper.
- * Lorem ipsum dolor sit amet, consectetur adipiscing elit. Etiam lobortis facilisis sem. Nullam nec mi et neque pharetra sollicitudin. Praesent imperdiet mi nec ante. Donec ullamcorper, felis non sodales commodo, lectus velit ultrices augue, a dignissim nibh lectus placerat pede. Vivamus nunc nunc, molestie ut, ultricies vel, semper in, velit. Ut porttitor. Praesent in sapien. Lorem ipsum dolor sit amet, consectetur adipiscing elit. Duis fringilla tristique neque. Sed interdum libero ut metus. Pellentesque placerat. Nam rutrum augue a leo. Morbi sed elit sit amet ante lobortis sollicitudin. Praesent blandit blandit mauris. Praesent lectus tellus, aliquet aliquam, luctus a, egestas a, turpis. Mauris lacinia lorem sit amet ipsum. Nunc quis urna dictum turpis accumsan semper.
- Lorem ipsum dolor sit amet, consectetur adipiscing elit. Etiam lobortis facilisis sem. Nullam nec mi et neque pharetra sollicitudin. Praesent imperdiet mi nec ante. Donec ullamcorper, felis non sodales commodo, lectus velit ultrices augue, a dignissim nibh lectus placerat pede. Vivamus nunc nunc, molestie ut, ultricies vel, semper in, velit. Ut porttitor. Praesent in sapien. Lorem ipsum dolor sit amet, consectetur adipiscing elit. Duis fringilla tristique neque. Sed interdum libero ut metus. Pellentesque placerat. Nam rutrum augue a leo. Morbi sed elit sit amet ante lobortis sollicitudin. Praesent blandit blandit mauris. Praesent lectus tellus, aliquet aliquam, luctus a, egestas a, turpis. Mauris lacinia lorem sit amet ipsum. Nunc quis urna dictum turpis accumsan semper.
- Lorem ipsum dolor sit amet, consectetur adipiscing elit. Etiam lobortis facilisis sem. Nullam nec mi et neque pharetra sollicitudin. Praesent imperdiet mi nec ante. Donec ullamcorper, felis non sodales commodo, lectus velit ultrices augue, a dignissim nibh lectus placerat pede. Vivamus nunc nunc, molestie ut, ultricies vel, semper in, velit. Ut

porttitor. Praesent in sapien. Lorem ipsum dolor sit amet, consectetur adipiscing elit. Duis fringilla tristique neque. Sed interdum libero ut metus. Pellentesque placerat. Nam rutrum augue a leo. Morbi sed elit sit amet ante lobortis sollicitudin. Praesent blandit blandit mauris. Praesent lectus tellus, aliquet aliquam, luctus a, egestas a, turpis. Mauris lacinia lorem sit amet ipsum. Nunc quis urna dictum turpis accumsan semper.

9.2.2 Example for list (enumerate)

1. Lorem ipsum dolor sit amet, consectetur adipiscing elit. Etiam lobortis facilisis sem. Nullam nec mi et neque pharetra sollicitudin. Praesent imperdiet mi nec ante. Donec ullamcorper, felis non sodales commodo, lectus velit ultrices augue, a dignissim nibh lectus placerat pede. Vivamus nunc nunc, molestie ut, ultricies vel, semper in, velit. Ut porttitor. Praesent in sapien. Lorem ipsum dolor sit amet, consectetur adipiscing elit. Duis fringilla tristique neque. Sed interdum libero ut metus. Pellentesque placerat. Nam rutrum augue a leo. Morbi sed elit sit amet ante lobortis sollicitudin. Praesent blandit blandit mauris. Praesent lectus tellus, aliquet aliquam, luctus a, egestas a, turpis. Mauris lacinia lorem sit amet ipsum. Nunc quis urna dictum turpis accumsan semper.
2. Lorem ipsum dolor sit amet, consectetur adipiscing elit. Etiam lobortis facilisis sem. Nullam nec mi et neque pharetra sollicitudin. Praesent imperdiet mi nec ante. Donec ullamcorper, felis non sodales commodo, lectus velit ultrices augue, a dignissim nibh lectus placerat pede. Vivamus nunc nunc, molestie ut, ultricies vel, semper in, velit. Ut porttitor. Praesent in sapien. Lorem ipsum dolor sit amet, consectetur adipiscing elit. Duis fringilla tristique neque. Sed interdum libero ut metus. Pellentesque placerat. Nam rutrum augue a leo. Morbi sed elit sit amet ante lobortis sollicitudin. Praesent blandit blandit mauris. Praesent lectus tellus, aliquet aliquam, luctus a, egestas a, turpis. Mauris lacinia lorem sit amet ipsum. Nunc quis urna dictum turpis accumsan semper.
3. Lorem ipsum dolor sit amet, consectetur adipiscing elit. Etiam lobortis facilisis sem. Nullam nec mi et neque pharetra sollicitudin. Praesent imperdiet mi nec ante. Donec ullamcorper, felis non sodales commodo, lectus velit ultrices augue, a dignissim nibh lectus placerat pede. Vivamus nunc nunc, molestie ut, ultricies vel, semper in, velit. Ut porttitor. Praesent in sapien. Lorem ipsum dolor sit amet, consectetur adipiscing elit. Duis fringilla tristique neque. Sed interdum libero ut metus. Pellentesque placerat. Nam rutrum augue a leo. Morbi sed elit sit amet ante lobortis sollicitudin. Praesent blandit blandit mauris. Praesent lectus tellus, aliquet aliquam, luctus a, egestas a, turpis. Mauris lacinia lorem sit amet ipsum. Nunc quis urna dictum turpis accumsan

semper.

4. Lorem ipsum dolor sit amet, consectetur adipiscing elit. Etiam lobortis facilisis sem. Nullam nec mi et neque pharetra sollicitudin. Praesent imperdiet mi nec ante. Donec ullamcorper, felis non sodales commodo, lectus velit ultrices augue, a dignissim nibh lectus placerat pede. Vivamus nunc nunc, molestie ut, ultricies vel, semper in, velit. Ut porttitor. Praesent in sapien. Lorem ipsum dolor sit amet, consectetur adipiscing elit. Duis fringilla tristique neque. Sed interdum libero ut metus. Pellentesque placerat. Nam rutrum augue a leo. Morbi sed elit sit amet ante lobortis sollicitudin. Praesent blandit blandit mauris. Praesent lectus tellus, aliquet aliquam, luctus a, egestas a, turpis. Mauris lacinia lorem sit amet ipsum. Nunc quis urna dictum turpis accumsan semper.
5. Lorem ipsum dolor sit amet, consectetur adipiscing elit. Etiam lobortis facilisis sem. Nullam nec mi et neque pharetra sollicitudin. Praesent imperdiet mi nec ante. Donec ullamcorper, felis non sodales commodo, lectus velit ultrices augue, a dignissim nibh lectus placerat pede. Vivamus nunc nunc, molestie ut, ultricies vel, semper in, velit. Ut porttitor. Praesent in sapien. Lorem ipsum dolor sit amet, consectetur adipiscing elit. Duis fringilla tristique neque. Sed interdum libero ut metus. Pellentesque placerat. Nam rutrum augue a leo. Morbi sed elit sit amet ante lobortis sollicitudin. Praesent blandit blandit mauris. Praesent lectus tellus, aliquet aliquam, luctus a, egestas a, turpis. Mauris lacinia lorem sit amet ipsum. Nunc quis urna dictum turpis accumsan semper.

Example for list (4*enumerate)

1. Lorem ipsum dolor sit amet, consectetur adipiscing elit. Etiam lobortis facilisis sem. Nullam nec mi et neque pharetra sollicitudin. Praesent imperdiet mi nec ante. Donec ullamcorper, felis non sodales commodo, lectus velit ultrices augue, a dignissim nibh lectus placerat pede. Vivamus nunc nunc, molestie ut, ultricies vel, semper in, velit. Ut porttitor. Praesent in sapien. Lorem ipsum dolor sit amet, consectetur adipiscing elit. Duis fringilla tristique neque. Sed interdum libero ut metus. Pellentesque placerat. Nam rutrum augue a leo. Morbi sed elit sit amet ante lobortis sollicitudin. Praesent blandit blandit mauris. Praesent lectus tellus, aliquet aliquam, luctus a, egestas a, turpis. Mauris lacinia lorem sit amet ipsum. Nunc quis urna dictum turpis accumsan semper.
 - a) Lorem ipsum dolor sit amet, consectetur adipiscing elit. Etiam lobortis facilisis sem. Nullam nec mi et neque pharetra sollicitudin. Praesent imperdiet mi nec ante. Donec ullamcorper, felis non sodales commodo, lectus velit ultrices augue, a dignissim nibh lectus placerat pede. Vivamus nunc nunc, molestie ut, ultricies

vel, semper in, velit. Ut porttitor. Praesent in sapien. Lorem ipsum dolor sit amet, consectetur adipiscing elit. Duis fringilla tristique neque. Sed interdum libero ut metus. Pellentesque placerat. Nam rutrum augue a leo. Morbi sed elit sit amet ante lobortis sollicitudin. Praesent blandit blandit mauris. Praesent lectus tellus, aliquet aliquam, luctus a, egestas a, turpis. Mauris lacinia lorem sit amet ipsum. Nunc quis urna dictum turpis accumsan semper.

- i. Lorem ipsum dolor sit amet, consectetur adipiscing elit. Etiam lobortis facilisis sem. Nullam nec mi et neque pharetra sollicitudin. Praesent imperdiet mi nec ante. Donec ullamcorper, felis non sodales commodo, lectus velit ultrices augue, a dignissim nibh lectus placerat pede. Vivamus nunc nunc, molestie ut, ultricies vel, semper in, velit. Ut porttitor. Praesent in sapien. Lorem ipsum dolor sit amet, consectetur adipiscing elit. Duis fringilla tristique neque. Sed interdum libero ut metus. Pellentesque placerat. Nam rutrum augue a leo. Morbi sed elit sit amet ante lobortis sollicitudin. Praesent blandit blandit mauris. Praesent lectus tellus, aliquet aliquam, luctus a, egestas a, turpis. Mauris lacinia lorem sit amet ipsum. Nunc quis urna dictum turpis accumsan semper.

A. Lorem ipsum dolor sit amet, consectetur adipiscing elit. Etiam lobortis facilisis sem. Nullam nec mi et neque pharetra sollicitudin. Praesent imperdiet mi nec ante. Donec ullamcorper, felis non sodales commodo, lectus velit ultrices augue, a dignissim nibh lectus placerat pede. Vivamus nunc nunc, molestie ut, ultricies vel, semper in, velit. Ut porttitor. Praesent in sapien. Lorem ipsum dolor sit amet, consectetur adipiscing elit. Duis fringilla tristique neque. Sed interdum libero ut metus. Pellentesque placerat. Nam rutrum augue a leo. Morbi sed elit sit amet ante lobortis sollicitudin. Praesent blandit blandit mauris. Praesent lectus tellus, aliquet aliquam, luctus a, egestas a, turpis. Mauris lacinia lorem sit amet ipsum. Nunc quis urna dictum turpis accumsan semper.

B. Lorem ipsum dolor sit amet, consectetur adipiscing elit. Etiam lobortis facilisis sem. Nullam nec mi et neque pharetra sollicitudin. Praesent imperdiet mi nec ante. Donec ullamcorper, felis non sodales commodo, lectus velit ultrices augue, a dignissim nibh lectus placerat pede. Vivamus nunc nunc, molestie ut, ultricies vel, semper in, velit. Ut porttitor. Praesent in sapien. Lorem ipsum dolor sit amet, consectetur adipiscing elit. Duis fringilla tristique neque. Sed interdum libero ut metus. Pellentesque placerat. Nam rutrum augue a leo. Morbi sed elit sit amet ante lobortis sollicitudin. Praesent blandit blandit mauris. Praesent lectus tellus, aliquet aliquam, luctus a, egestas a, turpis. Mauris lacinia lorem

sit amet ipsum. Nunc quis urna dictum turpis accumsan semper.

ii. Lorem ipsum dolor sit amet, consectetur adipiscing elit. Etiam lobortis facilisis sem. Nullam nec mi et neque pharetra sollicitudin. Praesent imperdiet mi nec ante. Donec ullamcorper, felis non sodales commodo, lectus velit ultrices augue, a dignissim nibh lectus placerat pede. Vivamus nunc nunc, molestie ut, ultricies vel, semper in, velit. Ut porttitor. Praesent in sapien. Lorem ipsum dolor sit amet, consectetur adipiscing elit. Duis fringilla tristique neque. Sed interdum libero ut metus. Pellentesque placerat. Nam rutrum augue a leo. Morbi sed elit sit amet ante lobortis sollicitudin. Praesent blandit blandit mauris. Praesent lectus tellus, aliquet aliquam, luctus a, egestas a, turpis. Mauris lacinia lorem sit amet ipsum. Nunc quis urna dictum turpis accumsan semper.

b) Lorem ipsum dolor sit amet, consectetur adipiscing elit. Etiam lobortis facilisis sem. Nullam nec mi et neque pharetra sollicitudin. Praesent imperdiet mi nec ante. Donec ullamcorper, felis non sodales commodo, lectus velit ultrices augue, a dignissim nibh lectus placerat pede. Vivamus nunc nunc, molestie ut, ultricies vel, semper in, velit. Ut porttitor. Praesent in sapien. Lorem ipsum dolor sit amet, consectetur adipiscing elit. Duis fringilla tristique neque. Sed interdum libero ut metus. Pellentesque placerat. Nam rutrum augue a leo. Morbi sed elit sit amet ante lobortis sollicitudin. Praesent blandit blandit mauris. Praesent lectus tellus, aliquet aliquam, luctus a, egestas a, turpis. Mauris lacinia lorem sit amet ipsum. Nunc quis urna dictum turpis accumsan semper.

2. Lorem ipsum dolor sit amet, consectetur adipiscing elit. Etiam lobortis facilisis sem. Nullam nec mi et neque pharetra sollicitudin. Praesent imperdiet mi nec ante. Donec ullamcorper, felis non sodales commodo, lectus velit ultrices augue, a dignissim nibh lectus placerat pede. Vivamus nunc nunc, molestie ut, ultricies vel, semper in, velit. Ut porttitor. Praesent in sapien. Lorem ipsum dolor sit amet, consectetur adipiscing elit. Duis fringilla tristique neque. Sed interdum libero ut metus. Pellentesque placerat. Nam rutrum augue a leo. Morbi sed elit sit amet ante lobortis sollicitudin. Praesent blandit blandit mauris. Praesent lectus tellus, aliquet aliquam, luctus a, egestas a, turpis. Mauris lacinia lorem sit amet ipsum. Nunc quis urna dictum turpis accumsan semper.

9.2.3 Example for list (description)

First itemtext Lorem ipsum dolor sit amet, consectetur adipiscing elit. Etiam lobortis facilisis sem. Nullam nec mi et neque pharetra sollicitudin. Praesent imperdiet mi nec ante. Donec ullamcorper, felis non sodales commodo, lectus velit ultrices augue,

a dignissim nibh lectus placerat pede. Vivamus nunc nunc, molestie ut, ultricies vel, semper in, velit. Ut porttitor. Praesent in sapien. Lorem ipsum dolor sit amet, consectetur adipiscing elit. Duis fringilla tristique neque. Sed interdum libero ut metus. Pellentesque placerat. Nam rutrum augue a leo. Morbi sed elit sit amet ante lobortis sollicitudin. Praesent blandit blandit mauris. Praesent lectus tellus, aliquet aliquam, luctus a, egestas a, turpis. Mauris lacinia lorem sit amet ipsum. Nunc quis urna dictum turpis accumsan semper.

Second itemtext Lorem ipsum dolor sit amet, consectetur adipiscing elit. Etiam lobortis facilisis sem. Nullam nec mi et neque pharetra sollicitudin. Praesent imperdiet mi nec ante. Donec ullamcorper, felis non sodales commodo, lectus velit ultrices augue, a dignissim nibh lectus placerat pede. Vivamus nunc nunc, molestie ut, ultricies vel, semper in, velit. Ut porttitor. Praesent in sapien. Lorem ipsum dolor sit amet, consectetur adipiscing elit. Duis fringilla tristique neque. Sed interdum libero ut metus. Pellentesque placerat. Nam rutrum augue a leo. Morbi sed elit sit amet ante lobortis sollicitudin. Praesent blandit blandit mauris. Praesent lectus tellus, aliquet aliquam, luctus a, egestas a, turpis. Mauris lacinia lorem sit amet ipsum. Nunc quis urna dictum turpis accumsan semper.

Last itemtext Lorem ipsum dolor sit amet, consectetur adipiscing elit. Etiam lobortis facilisis sem. Nullam nec mi et neque pharetra sollicitudin. Praesent imperdiet mi nec ante. Donec ullamcorper, felis non sodales commodo, lectus velit ultrices augue, a dignissim nibh lectus placerat pede. Vivamus nunc nunc, molestie ut, ultricies vel, semper in, velit. Ut porttitor. Praesent in sapien. Lorem ipsum dolor sit amet, consectetur adipiscing elit. Duis fringilla tristique neque. Sed interdum libero ut metus. Pellentesque placerat. Nam rutrum augue a leo. Morbi sed elit sit amet ante lobortis sollicitudin. Praesent blandit blandit mauris. Praesent lectus tellus, aliquet aliquam, luctus a, egestas a, turpis. Mauris lacinia lorem sit amet ipsum. Nunc quis urna dictum turpis accumsan semper.

First itemtext Lorem ipsum dolor sit amet, consectetur adipiscing elit. Etiam lobortis facilisis sem. Nullam nec mi et neque pharetra sollicitudin. Praesent imperdiet mi nec ante. Donec ullamcorper, felis non sodales commodo, lectus velit ultrices augue, a dignissim nibh lectus placerat pede. Vivamus nunc nunc, molestie ut, ultricies vel, semper in, velit. Ut porttitor. Praesent in sapien. Lorem ipsum dolor sit amet, consectetur adipiscing elit. Duis fringilla tristique neque. Sed interdum libero ut metus. Pellentesque placerat. Nam rutrum augue a leo. Morbi sed elit sit amet ante lobortis sollicitudin. Praesent blandit blandit mauris. Praesent lectus tellus, aliquet aliquam, luctus a, egestas a, turpis. Mauris lacinia lorem sit amet ipsum. Nunc quis urna dictum turpis accumsan semper.

Second itemtext Lorem ipsum dolor sit amet, consectetur adipiscing elit. Etiam lobortis facilisis sem. Nullam nec mi et neque pharetra sollicitudin. Praesent imperdiet mi nec ante. Donec ullamcorper, felis non sodales commodo, lectus velit ultrices augue, a dignissim nibh lectus placerat pede. Vivamus nunc nunc, molestie ut, ultricies vel, semper in, velit. Ut porttitor. Praesent in sapien. Lorem ipsum dolor sit amet, consectetur adipiscing elit. Duis fringilla tristique neque. Sed interdum libero ut metus. Pellentesque placerat. Nam rutrum augue a leo. Morbi sed elit sit amet ante lobortis sollicitudin. Praesent blandit blandit mauris. Praesent lectus tellus, aliquet aliquam, luctus a, egestas a, turpis. Mauris lacinia lorem sit amet ipsum. Nunc quis urna dictum turpis accumsan semper.

Example for list (4*description)

First itemtext Lorem ipsum dolor sit amet, consectetur adipiscing elit. Etiam lobortis facilisis sem. Nullam nec mi et neque pharetra sollicitudin. Praesent imperdiet mi nec ante. Donec ullamcorper, felis non sodales commodo, lectus velit ultrices augue, a dignissim nibh lectus placerat pede. Vivamus nunc nunc, molestie ut, ultricies vel, semper in, velit. Ut porttitor. Praesent in sapien. Lorem ipsum dolor sit amet, consectetur adipiscing elit. Duis fringilla tristique neque. Sed interdum libero ut metus. Pellentesque placerat. Nam rutrum augue a leo. Morbi sed elit sit amet ante lobortis sollicitudin. Praesent blandit blandit mauris. Praesent lectus tellus, aliquet aliquam, luctus a, egestas a, turpis. Mauris lacinia lorem sit amet ipsum. Nunc quis urna dictum turpis accumsan semper.

First itemtext Lorem ipsum dolor sit amet, consectetur adipiscing elit. Etiam lobortis facilisis sem. Nullam nec mi et neque pharetra sollicitudin. Praesent imperdiet mi nec ante. Donec ullamcorper, felis non sodales commodo, lectus velit ultrices augue, a dignissim nibh lectus placerat pede. Vivamus nunc nunc, molestie ut, ultricies vel, semper in, velit. Ut porttitor. Praesent in sapien. Lorem ipsum dolor sit amet, consectetur adipiscing elit. Duis fringilla tristique neque. Sed interdum libero ut metus. Pellentesque placerat. Nam rutrum augue a leo. Morbi sed elit sit amet ante lobortis sollicitudin. Praesent blandit blandit mauris. Praesent lectus tellus, aliquet aliquam, luctus a, egestas a, turpis. Mauris lacinia lorem sit amet ipsum. Nunc quis urna dictum turpis accumsan semper.

First itemtext Lorem ipsum dolor sit amet, consectetur adipiscing elit. Etiam lobortis facilisis sem. Nullam nec mi et neque pharetra sollicitudin. Praesent imperdiet mi nec ante. Donec ullamcorper, felis non sodales commodo, lectus velit ultrices augue, a dignissim nibh lectus placerat pede. Vivamus nunc nunc, molestie ut, ultricies vel, semper in, velit. Ut porttitor. Praesent in sapien. Lorem ipsum dolor sit amet, consectetur adipiscing elit.

Duis fringilla tristique neque. Sed interdum libero ut metus. Pellentesque placerat. Nam rutrum augue a leo. Morbi sed elit sit amet ante lobortis sollicitudin. Praesent blandit blandit mauris. Praesent lectus tellus, aliquet aliquam, luctus a, egestas a, turpis. Mauris lacinia lorem sit amet ipsum. Nunc quis urna dictum turpis accumsan semper.

First itemtext Lorem ipsum dolor sit amet, consectetur adipiscing elit. Etiam lobortis facilisis sem. Nullam nec mi et neque pharetra sollicitudin. Praesent imperdiet mi nec ante. Donec ullamcorper, felis non sodales commodo, lectus velit ultrices augue, a dignissim nibh lectus placerat pede. Vivamus nunc nunc, molestie ut, ultricies vel, semper in, velit. Ut porttitor. Praesent in sapien. Lorem ipsum dolor sit amet, consectetur adipiscing elit. Duis fringilla tristique neque. Sed interdum libero ut metus. Pellentesque placerat. Nam rutrum augue a leo. Morbi sed elit sit amet ante lobortis sollicitudin. Praesent blandit blandit mauris. Praesent lectus tellus, aliquet aliquam, luctus a, egestas a, turpis. Mauris lacinia lorem sit amet ipsum. Nunc quis urna dictum turpis accumsan semper.

Second itemtext Lorem ipsum dolor sit amet, consectetur adipiscing elit. Etiam lobortis facilisis sem. Nullam nec mi et neque pharetra sollicitudin. Praesent imperdiet mi nec ante. Donec ullamcorper, felis non sodales commodo, lectus velit ultrices augue, a dignissim nibh lectus placerat pede. Vivamus nunc nunc, molestie ut, ultricies vel, semper in, velit. Ut porttitor. Praesent in sapien. Lorem ipsum dolor sit amet, consectetur adipiscing elit. Duis fringilla tristique neque. Sed interdum libero ut metus. Pellentesque placerat. Nam rutrum augue a leo. Morbi sed elit sit amet ante lobortis sollicitudin. Praesent blandit blandit mauris. Praesent lectus tellus, aliquet aliquam, luctus a, egestas a, turpis. Mauris lacinia lorem sit amet ipsum. Nunc quis urna dictum turpis accumsan semper.

Last itemtext Lorem ipsum dolor sit amet, consectetur adipiscing elit. Etiam lobortis facilisis sem. Nullam nec mi et neque pharetra sollicitudin. Praesent imperdiet mi nec ante. Donec ullamcorper, felis non sodales commodo, lectus velit ultrices augue, a dignissim nibh lectus placerat pede. Vivamus nunc nunc, molestie ut, ultricies vel, semper in, velit. Ut porttitor. Praesent in sapien. Lorem ipsum dolor sit amet, consectetur adipiscing elit. Duis fringilla tristique neque. Sed interdum libero ut metus. Pellentesque placerat. Nam rutrum augue a leo. Morbi sed elit sit amet ante lobortis sollicitudin. Praesent blandit blandit mauris. Praesent lectus tellus, aliquet aliquam, luctus a, egestas a, turpis. Mauris lacinia lorem sit amet ipsum. Nunc quis urna dictum turpis accumsan semper.

First itemtext Lorem ipsum dolor sit amet, consectetur adipiscing elit. Etiam lobortis facilisis sem. Nullam nec mi et neque pharetra sollicitudin. Praesent imperdiet mi nec ante. Donec ullamcorper, felis non sodales commodo, lectus velit ultrices augue, a dignissim nibh lectus placerat pede. Vivamus nunc nunc, molestie ut, ultricies vel, semper in, velit. Ut porttitor. Praesent in sapien. Lorem ipsum dolor sit amet, consectetur adipiscing elit. Duis fringilla tristique neque. Sed interdum libero ut metus. Pellentesque placerat. Nam rutrum augue a leo. Morbi sed elit sit amet ante lobortis sollicitudin. Praesent blandit blandit mauris. Praesent lectus tellus, aliquet aliquam, luctus a, egestas a, turpis. Mauris lacinia lorem sit amet ipsum. Nunc quis urna dictum turpis accumsan semper.

Second itemtext Lorem ipsum dolor sit amet, consectetur adipiscing elit. Etiam lobortis facilisis sem. Nullam nec mi et neque pharetra sollicitudin. Praesent imperdiet mi nec ante. Donec ullamcorper, felis non sodales commodo, lectus velit ultrices augue, a dignissim nibh lectus placerat pede. Vivamus nunc nunc, molestie ut, ultricies vel, semper in, velit. Ut porttitor. Praesent in sapien. Lorem ipsum dolor sit amet, consectetur adipiscing elit. Duis fringilla tristique neque. Sed interdum libero ut metus. Pellentesque placerat. Nam rutrum augue a leo. Morbi sed elit sit amet ante lobortis sollicitudin. Praesent blandit blandit mauris. Praesent lectus tellus, aliquet aliquam, luctus a, egestas a, turpis. Mauris lacinia lorem sit amet ipsum. Nunc quis urna dictum turpis accumsan semper.

Lorem ipsum dolor sit amet, consectetur adipiscing elit. Etiam lobortis facilisis sem. Nullam nec mi et neque pharetra sollicitudin. Praesent imperdiet mi nec ante. Donec ullamcorper, felis non sodales commodo, lectus velit ultrices augue, a dignissim nibh lectus placerat pede. Vivamus nunc nunc, molestie ut, ultricies vel, semper in, velit. Ut porttitor. Praesent in sapien. Lorem ipsum dolor sit amet, consectetur adipiscing elit. Duis fringilla tristique neque. Sed interdum libero ut metus. Pellentesque placerat. Nam rutrum augue a leo. Morbi sed elit sit amet ante lobortis sollicitudin. Praesent blandit blandit mauris. Praesent lectus tellus, aliquet aliquam, luctus a, egestas a, turpis. Mauris lacinia lorem sit amet ipsum. Nunc quis urna dictum turpis accumsan semper. Lorem ipsum dolor sit amet, consectetur adipiscing elit. Etiam lobortis facilisis sem. Nullam nec mi et neque pharetra sollicitudin. Praesent imperdiet mi nec ante. Donec ullamcorper, felis non sodales commodo, lectus velit ultrices augue, a dignissim nibh lectus placerat pede. Vivamus nunc nunc, molestie ut, ultricies vel, semper in, velit. Ut porttitor. Praesent in sapien. Lorem ipsum dolor sit amet, consectetur adipiscing elit. Duis fringilla tristique neque. Sed interdum libero ut metus. Pellentesque placerat. Nam rutrum augue a leo. Morbi sed elit sit amet ante lobortis sollicitudin. Praesent blandit blandit mauris. Praesent lectus tellus, aliquet aliquam, luctus a, egestas a, turpis. Mauris lacinia lorem sit amet ipsum. Nunc quis urna dictum turpis accumsan semper. Lorem ipsum dolor sit amet, consectetur adipiscing elit. Etiam lobortis

facilisis sem. Nullam nec mi et neque pharetra sollicitudin. Praesent imperdiet mi nec ante. Donec ullamcorper, felis non sodales commodo, lectus velit ultrices augue, a dignissim nibh lectus placerat pede. Vivamus nunc nunc, molestie ut, ultricies vel, semper in, velit. Ut porttitor. Praesent in sapien. Lorem ipsum dolor sit amet, consectetur adipiscing elit. Duis fringilla tristique neque. Sed interdum libero ut metus. Pellentesque placerat. Nam rutrum augue a leo. Morbi sed elit sit amet ante lobortis sollicitudin. Praesent blandit blandit mauris. Praesent lectus tellus, aliquet aliquam, luctus a, egestas a, turpis. Mauris lacinia lorem sit amet ipsum. Nunc quis urna dictum turpis accumsan semper. Lorem ipsum dolor sit amet, consectetur adipiscing elit. Etiam lobortis facilisis sem. Nullam nec mi et neque pharetra sollicitudin. Praesent imperdiet mi nec ante. Donec ullamcorper, felis non sodales commodo, lectus velit ultrices augue, a dignissim nibh lectus placerat pede. Vivamus nunc nunc, molestie ut, ultricies vel, semper in, velit. Ut porttitor. Praesent in sapien. Lorem ipsum dolor sit amet, consectetur adipiscing elit. Duis fringilla tristique neque. Sed interdum libero ut metus. Pellentesque placerat. Nam rutrum augue a leo. Morbi sed elit sit amet ante lobortis sollicitudin. Praesent blandit blandit mauris. Praesent lectus tellus, aliquet aliquam, luctus a, egestas a, turpis. Mauris lacinia lorem sit amet ipsum. Nunc quis urna dictum turpis accumsan semper. Lorem ipsum dolor sit amet, consectetur adipiscing elit. Etiam lobortis facilisis sem. Nullam nec mi et neque pharetra sollicitudin. Praesent imperdiet mi nec ante. Donec ullamcorper, felis non sodales commodo, lectus velit ultrices augue, a dignissim nibh lectus placerat pede. Vivamus nunc nunc, molestie ut, ultricies vel, semper in, velit. Ut porttitor. Praesent in sapien. Lorem ipsum dolor sit amet, consectetur adipiscing elit. Duis fringilla tristique neque. Sed interdum libero ut metus. Pellentesque placerat. Nam rutrum augue a leo. Morbi sed elit sit amet ante lobortis sollicitudin. Praesent blandit blandit mauris. Praesent lectus tellus, aliquet aliquam, luctus a, egestas a, turpis. Mauris lacinia lorem sit amet ipsum. Nunc quis urna dictum turpis accumsan semper.

First itemtext

Second itemtext

Last itemtext

First itemtext

Second itemtext

- First itemtext
- Second itemtext
- Last itemtext
- First itemtext

- Second itemtext

1. First itemtext
2. Second itemtext
3. Last itemtext
4. First itemtext
5. Second itemtext

First itemtext

Second itemtext

Last itemtext

First itemtext

Second itemtext

1. First itemtext
2. Second itemtext
3. Last itemtext
4. First itemtext
5. Second itemtext
6. Last itemtext
7. First itemtext
8. Second itemtext
9. Last itemtext
10. First itemtext

Lorem ipsum dolor sit amet, consectetur adipiscing elit. Etiam lobortis facilisis sem. Nullam nec mi et neque pharetra sollicitudin. Praesent imperdiet mi nec ante. Donec ullamcorper, felis non sodales commodo, lectus velit ultrices augue, a dignissim nibh lectus placerat pede. Vivamus nunc nunc, molestie ut, ultricies vel, semper in, velit. Ut porttitor. Praesent in sapien. Lorem ipsum dolor sit amet, consectetur adipiscing elit. Duis fringilla

tristique neque. Sed interdum libero ut metus. Pellentesque placerat. Nam rutrum augue a leo. Morbi sed elit sit amet ante lobortis sollicitudin. Praesent blandit blandit mauris. Praesent lectus tellus, aliquet aliquam, luctus a, egestas a, turpis. Mauris lacinia lorem sit amet ipsum. Nunc quis urna dictum turpis accumsan semper. Lorem ipsum dolor sit amet, consectetur adipiscing elit. Etiam lobortis facilisis sem. Nullam nec mi et neque pharetra sollicitudin. Praesent imperdiet mi nec ante. Donec ullamcorper, felis non sodales commodo, lectus velit ultrices augue, a dignissim nibh lectus placerat pede. Vivamus nunc nunc, molestie ut, ultricies vel, semper in, velit. Ut porttitor. Praesent in sapien. Lorem ipsum dolor sit amet, consectetur adipiscing elit. Duis fringilla tristique neque. Sed interdum libero ut metus. Pellentesque placerat. Nam rutrum augue a leo. Morbi sed elit sit amet ante lobortis sollicitudin. Praesent blandit blandit mauris. Praesent lectus tellus, aliquet aliquam, luctus a, egestas a, turpis. Mauris lacinia lorem sit amet ipsum. Nunc quis urna dictum turpis accumsan semper.

Lorem ipsum dolor sit amet, consectetur adipiscing elit. Etiam lobortis facilisis sem. Nullam nec mi et neque pharetra sollicitudin. Praesent imperdiet mi nec ante. Donec ullamcorper, felis non sodales commodo, lectus velit ultrices augue, a dignissim nibh lectus placerat pede. Vivamus nunc nunc, molestie ut, ultricies vel, semper in, velit. Ut porttitor. Praesent in sapien. Lorem ipsum dolor sit amet, consectetur adipiscing elit. Duis fringilla tristique neque. Sed interdum libero ut metus. Pellentesque placerat. Nam rutrum augue a leo. Morbi sed elit sit amet ante lobortis sollicitudin. Praesent blandit blandit mauris. Praesent lectus tellus, aliquet aliquam, luctus a, egestas a, turpis. Mauris lacinia lorem sit amet ipsum. Nunc quis urna dictum turpis accumsan semper.

$$\bar{x} = \frac{1}{n} \sum_{i=1}^{i=n} x_i = \frac{x_1 + x_2 + \dots + x_n}{n}$$

Lorem ipsum dolor sit amet, consectetur adipiscing elit. Etiam lobortis facilisis sem. Nullam nec mi et neque pharetra sollicitudin. Praesent imperdiet mi nec ante. Donec ullamcorper, felis non sodales commodo, lectus velit ultrices augue, a dignissim nibh lectus placerat pede. Vivamus nunc nunc, molestie ut, ultricies vel, semper in, velit. Ut porttitor. Praesent in sapien. Lorem ipsum dolor sit amet, consectetur adipiscing elit. Duis fringilla tristique neque. Sed interdum libero ut metus. Pellentesque placerat. Nam rutrum augue a leo. Morbi sed elit sit amet ante lobortis sollicitudin. Praesent blandit blandit mauris. Praesent lectus tellus, aliquet aliquam, luctus a, egestas a, turpis. Mauris lacinia lorem sit amet ipsum. Nunc quis urna dictum turpis accumsan semper.

$$\int_0^{\infty} e^{-\alpha x^2} dx = \frac{1}{2} \sqrt{\int_{-\infty}^{\infty} e^{-\alpha x^2} dx} \int_{-\infty}^{\infty} e^{-\alpha y^2} dy = \frac{1}{2} \sqrt{\frac{\pi}{\alpha}}$$

Lorem ipsum dolor sit amet, consectetur adipiscing elit. Etiam lobortis facilisis sem. Nullam

nec mi et neque pharetra sollicitudin. Praesent imperdiet mi nec ante. Donec ullamcorper, felis non sodales commodo, lectus velit ultrices augue, a dignissim nibh lectus placerat pede. Vivamus nunc nunc, molestie ut, ultricies vel, semper in, velit. Ut porttitor. Praesent in sapien. Lorem ipsum dolor sit amet, consectetur adipiscing elit. Duis fringilla tristique neque. Sed interdum libero ut metus. Pellentesque placerat. Nam rutrum augue a leo. Morbi sed elit sit amet ante lobortis sollicitudin. Praesent blandit blandit mauris. Praesent lectus tellus, aliquet aliquam, luctus a, egestas a, turpis. Mauris lacinia lorem sit amet ipsum. Nunc quis urna dictum turpis accumsan semper.

$$\sum_{k=0}^{\infty} a_0 q^k = \lim_{n \rightarrow \infty} \sum_{k=0}^n a_0 q^k = \lim_{n \rightarrow \infty} a_0 \frac{1 - q^{n+1}}{1 - q} = \frac{a_0}{1 - q}$$

Lorem ipsum dolor sit amet, consectetur adipiscing elit. Etiam lobortis facilisis sem. Nullam nec mi et neque pharetra sollicitudin. Praesent imperdiet mi nec ante. Donec ullamcorper, felis non sodales commodo, lectus velit ultrices augue, a dignissim nibh lectus placerat pede. Vivamus nunc nunc, molestie ut, ultricies vel, semper in, velit. Ut porttitor. Praesent in sapien. Lorem ipsum dolor sit amet, consectetur adipiscing elit. Duis fringilla tristique neque. Sed interdum libero ut metus. Pellentesque placerat. Nam rutrum augue a leo. Morbi sed elit sit amet ante lobortis sollicitudin. Praesent blandit blandit mauris. Praesent lectus tellus, aliquet aliquam, luctus a, egestas a, turpis. Mauris lacinia lorem sit amet ipsum. Nunc quis urna dictum turpis accumsan semper.

$$x_{1,2} = \frac{-b \pm \sqrt{b^2 - 4ac}}{2a} = \frac{-p \pm \sqrt{p^2 - 4q}}{2}$$

Lorem ipsum dolor sit amet, consectetur adipiscing elit. Etiam lobortis facilisis sem. Nullam nec mi et neque pharetra sollicitudin. Praesent imperdiet mi nec ante. Donec ullamcorper, felis non sodales commodo, lectus velit ultrices augue, a dignissim nibh lectus placerat pede. Vivamus nunc nunc, molestie ut, ultricies vel, semper in, velit. Ut porttitor. Praesent in sapien. Lorem ipsum dolor sit amet, consectetur adipiscing elit. Duis fringilla tristique neque. Sed interdum libero ut metus. Pellentesque placerat. Nam rutrum augue a leo. Morbi sed elit sit amet ante lobortis sollicitudin. Praesent blandit blandit mauris. Praesent lectus tellus, aliquet aliquam, luctus a, egestas a, turpis. Mauris lacinia lorem sit amet ipsum. Nunc quis urna dictum turpis accumsan semper.

$$\frac{\partial^2 \Phi}{\partial x^2} + \frac{\partial^2 \Phi}{\partial y^2} + \frac{\partial^2 \Phi}{\partial z^2} = \frac{1}{c^2} \frac{\partial^2 \Phi}{\partial t^2}$$

Lorem ipsum dolor sit amet, consectetur adipiscing elit. Etiam lobortis facilisis sem. Nullam nec mi et neque pharetra sollicitudin. Praesent imperdiet mi nec ante. Donec ullamcorper, felis non sodales commodo, lectus velit ultrices augue, a dignissim nibh lectus placerat pede.

Vivamus nunc nunc, molestie ut, ultricies vel, semper in, velit. Ut porttitor. Praesent in sapien. Lorem ipsum dolor sit amet, consectetur adipiscing elit. Duis fringilla tristique neque. Sed interdum libero ut metus. Pellentesque placerat. Nam rutrum augue a leo. Morbi sed elit sit amet ante lobortis sollicitudin. Praesent blandit blandit mauris. Praesent lectus tellus, aliquet aliquam, luctus a, egestas a, turpis. Mauris lacinia lorem sit amet ipsum. Nunc quis urna dictum turpis accumsan semper.

A

Appendix

Bibliography

- [1] J. Kuipers, “Quaternions and Rotation Sequences”, *Geometry, Integrability & Quantization*, vol. 1, pp. 127–143, 2000.
- [2] C. de Boor, “On calculating with B-splines”, *Journal of Approximation Theory*, vol. 6, no. 1, pp. 50–62, 1972.
- [3] K. J. Waldron and J. Schmiedeler, “Kinematics”, in *Springer Handbook of Robotics*, B. Siciliano and O. Khatib, Eds., Springer Berlin Heidelberg, 2016, pp. 11–35, ISBN: 978-3-319-32550-7.
- [4] L. Biagiotti and C. Melchiorri, *Trajectory Planning for Automatic Machines and Robots*. Berlin Heidelberg: Springer Berlin Heidelberg, 2008, ISBN: 978-3-540-85628-3.
- [5] G. Dahlquist, *Numerical methods in scientific computing*. Philadelphia: Society for Industrial and Applied Mathematics, 2008, ISBN: 978-0-898716-44-3.